

TEST REPORT

CERTIFICATE OF CONFORMITY

Standards: EN 55032:2015 +A11:2020, Class A
CISPR 32:2015 +Cor 1:2016, Class A
AS/NZS CISPR 32:2015, Class A
EN 61000-3-2:2014
EN 61000-3-3:2013
EN 55035:2017 +A11:2020

Report No.: CEBDBO-WTW-P21090209

Model No.: MTC-8010W

Series Model: MTC-8XXXXXXXXXXXXXXXXX
("X" can be 0-9, A-Z or blank for marketing purpose)

Received Date: 2021/9/6

Test Date: 2021/9/11 ~ 2021/9/20

Issued Date: 2021/10/19

Applicant: Vecow Co., Ltd.

Address: 3F., No.10, Jiankang Rd., Zhonghe Dist., New Taipei City 23586, Taiwan

Issued By: Bureau Veritas Consumer Products Services (H.K.) Ltd., Taoyuan Branch Lin Kou Laboratories

Lab Address: No. 47-2, 14th Ling, Chia Pau Vil., Lin Kou Dist., New Taipei City, Taiwan

Test Location: No. 47-2, 14th Ling, Chia Pau Vil., Lin Kou Dist., New Taipei City, Taiwan

Approved by :



Date: 2021/10/19

Jim Hsiang / Associate Technical Manager

This test report consists of 77 pages in total. It may be duplicated completely for legal use with the approval of the applicant. It should not be reproduced except in full, without the written approval of our laboratory. The test results in the report only apply to the tested sample. The test results in this report are traceable to the national or international standards.



Prepared by : Vivian Chen / Senior Specialist

Certificate #4327.01

This report is for your exclusive use. Any copying or replication of this report to or for any other person or entity, or use of our name or trademark, is permitted only with our prior written permission. This report sets forth our findings solely with respect to the test samples identified herein. The results set forth in this report are not indicative or representative of the quality or characteristics of the lot from which a test sample was taken or any similar or identical product unless specifically and expressly noted. Our report includes all of the tests requested by you and the results thereof based upon the information that you provided to us. You have 60 days from date of issuance of this report to notify us of any material error or omission caused by our negligence, provided, however, that such notice shall be in writing and shall specifically address the issue you wish to raise. A failure to raise such issue within the prescribed time shall constitute your unqualified acceptance of the completeness of this report, the tests conducted and the correctness of the report contents. Unless specific mention, the uncertainty of measurement has been explicitly taken into account to declare the compliance or non-compliance to the specification.

Table of Contents

Release Control Record	4
1 Certification	5
2 Summary of Test Results	6
2.1 Performance Criteria	7
2.2 Measurement Uncertainty	9
2.3 Supplementary Information	9
3 General Information	10
3.1 Description of EUT	10
3.2 Primary Clock Frequencies of Internal Source	10
3.3 Features of EUT	10
3.4 Operating Modes of EUT and Determination of Worst Case Operating Mode	11
3.5 Test Program Used and Operation Descriptions	12
3.6 Connection Diagram of EUT and Peripheral Devices	13
3.7 Configuration of Peripheral Devices and Cable Connections	15
4 Test Instruments	17
4.1 Conducted Emissions from Power Ports	17
4.2 Conducted Emissions from Wired Network Ports	18
4.3 Radiated Emissions up to 1 GHz	19
4.4 Radiated Emissions above 1 GHz	20
4.5 Harmonics Current Measurement	21
4.6 Voltage Fluctuations and Flicker Measurement	21
4.7 Electrostatic Discharge (ESD)	21
4.8 Radio Frequency Electromagnetic Field (RS)	22
4.9 Fast Transients Common Mode (EFT)	23
4.10 Surge	23
4.11 Radio Frequency Common Mode (CS)	24
4.12 Power Frequency Magnetic Field (PFMF)	25
4.13 Voltage Dips and Interruptions (DIP)	25
5 Limits of Test Items	26
5.1 Conducted Emissions from Power Ports	26
5.2 Conducted Emissions from Wired Network Ports	26
5.3 Radiated Emissions up to 1 GHz	26
5.4 Radiated Emissions above 1 GHz	27
5.5 Harmonic Current Measurement	28
5.6 Voltage Fluctuations and Flicker Measurement	29
5.7 General immunity requirements	30
6 Test Arrangements	32
6.1 Conducted Emissions from Power Ports	32
6.2 Conducted Emissions from Wired Network Ports	33
6.3 Radiated Emissions up to 1 GHz	36
6.4 Radiated Emissions above 1 GHz	37
6.5 Harmonics Current Measurement	38
6.6 Voltage Fluctuations and Flicker Measurement	38
6.7 Electrostatic Discharge (ESD)	39
6.8 Radio Frequency Electromagnetic Field (RS)	41
6.9 Fast Transients Common Mode (EFT)	42
6.10 Surge	43
6.11 Radio Frequency Common Mode (CS)	45
6.12 Power Frequency Magnetic Field (PFMF)	47
6.13 Voltage Dips and Interruptions (DIP)	48
7 Test Results	49

7.1	Conducted emissions from Power Ports	49
7.2	Conducted Emissions from Wired Network Ports	53
7.3	Radiated Emissions up to 1 GHz	54
7.4	Radiated Emissions above 1 GHz.....	56
7.5	Harmonic Current Measurement	58
7.6	Voltage Fluctuations and Flicker Measurement	58
7.7	Electrostatic Discharge (ESD)	59
7.8	Radio Frequency Electromagnetic Field (RS)	62
7.9	Fast Transients Common Mode (EFT)	62
7.10	Surge	63
7.11	Radio Frequency Common Mode (CS)	63
7.12	Power Frequency Magnetic Field (PFMF).....	64
7.13	Voltage Dips and Interruptions (DIP)	65
8	Pictures of Test Arrangements	66
8.1	Conducted Emissions from Power Ports.....	66
8.2	Conducted Emissions from Wired Network Ports	67
8.3	Radiated Emissions up to 1 GHz	68
8.4	Radiated Emissions above 1 GHz.....	69
8.5	Harmonic Current Measurement	70
8.6	Voltage Fluctuations and Flicker Measurement	70
8.7	Electrostatic Discharge (ESD)	71
8.8	Radio Frequency Electromagnetic Field (RS)	72
8.9	Fast Transients Common Mode (EFT)	73
8.10	Surge	74
8.11	Radio Frequency Common Mode (CS)	75
8.12	Power-frequency magnetic fields (PFMF)	76
8.13	Voltage Dips and Interruptions (DIP)	76
9	Information of the Testing Laboratories	77



Release Control Record

Issue No.	Description	Date Issued
CEBDBO-WTW-P21090209	Original release.	2021/10/19

1 Certification

Product: Ultra-Compact Embedded System

Brand: Vecow

Test Model: MTC-8010W

Series Model: MTC-8XXXXXXXXXXXXXXXXXX
("X" can be 0-9, A-Z or blank for marketing purpose)

Sample Status: Engineering sample

Applicant: Vecow Co., Ltd.

Test Date: 2021/9/11 ~ 2021/9/20

Standards: EN 55032:2015 +A11:2020, Class A
CISPR 32:2015 +Cor 1:2016, Class A
AS/NZS CISPR 32:2015, Class A
EN 61000-3-2:2014
EN 61000-3-3:2013
EN 55035:2017 +A11:2020

Measurement procedure: EN 61000-4-2:2009 / IEC 61000-4-2:2008 ED. 2.0
EN 61000-4-3:2006 +A1:2008 +A2:2010 / IEC 61000-4-3:2010 ED. 3.2
EN 61000-4-4:2012 / IEC 61000-4-4:2012 ED. 3.0
EN 61000-4-5:2014 +A1:2017 / IEC 61000-4-5:2017 ED. 3.1
EN 61000-4-6:2014+AC:2015 / IEC 61000-4-6:2013 ED. 4.0
EN 61000-4-8:2010 / IEC 61000-4-8:2009 ED. 2.0
EN 61000-4-11:2004 +A1: 2017 / IEC 61000-4-11:2017 ED. 2.1

The above equipment has been tested by **Bureau Veritas Consumer Products Services (H.K.) Ltd., Taoyuan Branch**, and found compliance with the requirement of the above standards. The test record, data evaluation & Equipment Under Test (EUT) configurations represented herein are true and accurate accounts of the measurements of the sample's EMC characteristics under the conditions specified in this report.

2 Summary of Test Results

The test items that the EUT needs to perform according to its interfaces and functions evaluation are as follows:

Standard	Test Item	Result	Remarks
EN 55032	Conducted Emissions from Power Ports	Pass	Minimum passing Class A margin is -4.10 dB at 1.00000 MHz.
EN 55032	Conducted Emissions from Wired Network Ports	Pass	Minimum passing Class A margin is -2.42 dB at 0.49999 MHz.
EN 55032	Radiated Emissions up to 1 GHz	Pass	Minimum passing Class A margin is -0.55 dB at 164.51 MHz
	Radiated Emissions above 1 GHz	Pass	Minimum passing Class A margin is -8.80 dB at 1499.75 MHz.
EN 61000-3-2	Harmonic Current Measurement	Pass	The power consumption of EUT is less than 75W and no limits apply.
EN 61000-3-3	Voltage Fluctuations and Flicker Measurement	Pass	Meets the requirements.
IEC 61000-4-2	Electrostatic Discharges (ESD)	Pass	For EN 55035 Performance Criteria B
IEC 61000-4-3	Radio Frequency Electromagnetic Field (RS)	Pass	For EN 55035 Performance Criteria A
IEC 61000-4-4	Fast Transients Common Mode (EFT)	Pass	For EN 55035 Performance Criteria A
IEC 61000-4-5	Surges	Pass	For EN 55035 Performance Criteria A
IEC 61000-4-6	Radio Frequency Common Mode (CS)	Pass	For EN 55035 Performance Criteria A
IEC 61000-4-8	Power Frequency Magnetic Field (PFMF)	Pass	For EN 55035 Performance Criteria A
IEC 61000-4-11	Voltage Dips and Interruptions (DIP)	Pass	For EN 55035 Voltage Dips: < 5 % residual, 0.5 cycle, Performance Criteria A 70% residual, 25 cycles Performance Criteria A Voltage Interruptions: < 5 % residual, 250 cycles Performance Criteria C

Note: Determining compliance based on the results of the compliance measurement, not taking into account measurement instrumentation uncertainty.

2.1 Performance Criteria

General Performance Criteria

These criteria shall be used during the testing of primary functions where no specified in the normative annexes of EN 55035 is applicable.

Performance criterion A

The equipment shall continue to operate as intended without operator intervention. No degradation of performance, loss of function or change of operating state is allowed below a performance level specified by the manufacturer when the equipment is used as intended. The performance level may be replaced by a permissible loss of performance. If the minimum performance level or the permissible performance loss is not specified by the manufacturer, then either of these may be derived from the product description and documentation, and by what the user may reasonably expect from the equipment if used as intended.

Performance criterion B

During the application of the disturbance, degradation of performance is allowed. However, no unintended change of actual operating state or stored data is allowed to persist after the test.

After the test, the equipment shall continue to operate as intended without operator intervention; no degradation of performance or loss of function is allowed, below a performance level specified by the manufacturer, when the equipment is used as intended. The performance level may be replaced by a permissible loss of performance.

If the minimum performance level (or the permissible performance loss), or recovery time, is not specified by the manufacturer, then either of these may be derived from the product description and documentation, and by what the user may reasonably expect from the equipment if used as intended.

Performance criterion C

Loss of function is allowed, provided the function is self-recoverable, or can be restored by the operation of the controls by the user in accordance with the manufacturer's instructions. A reboot or re-start operation is allowed.

Information stored in non-volatile memory, or protected by a battery backup, shall not be lost.

Product Specific Performance criteria for network functions

Equipment that provides these functions transmits and receives data through ports such as an analogue/digital data port. The networking functions are just like network switching and routing ; data transmission ; supervisory...etc.

The particular performance criteria which are specified in the normative annexes of CISPR 35/ EN 55035 take precedence over the corresponding parts of the general performance criteria.

Performance criterion A

Where relevant, during the application of the test the network function shall, as a minimum, operate ensuring that:

- established connections shall be maintained throughout the application of the test;
- no change of operational state or corruption of stored data occurs;
- no increase in error rate above the figure defined by the manufacturer occurs. The manufacturer should select the most appropriate performance measurement criteria for the product or system, for example bit error rate, block error rate;
- no request for retry above the figure defined by the manufacturer;
- the data transmission rate does not reduce below the figure defined by the manufacturer;
- no protocol failure occurs;
- other verifications are described in F.3.3.1 of CISPR 35/ EN 55035.

Performance criterion B

Established connections shall be maintained throughout the test, or shall self-recover in a way and timescale that is imperceptible to the user.

The error rate, request for retry and data transmission rates may be degraded during the application of the test. Degradation of the performance as described in criterion A is permitted, provided that the normal operation of the EUT is self-recoverable to the condition established prior to the application of the test.

Where required, as defined in Clause 5 of CISPR 35/ EN 55035, the acceptable operation of the function shall be verified at the completion of the test as described in Table H.1 of CISPR 35/ EN 55035, by confirming the following:

- the EUT's ability to establish a connection,
- the EUT's ability to clear a connection.

During surge testing disconnection is allowed on the analogue/digital data port being tested.

If the EUT is a supervisory equipment, it shall not impact the normal operation of the network being monitored. In addition, any supervisory functions impacted during the period of the test shall return to the state prior to the test. Elements to consider include: alarms, signalling lamps, printer output, network traffic rates, network monitoring.

Performance criterion C

Degradation of performance as described in criteria A and B is permitted provided that the normal operation of the EUT is self-recoverable to the condition immediately before the application of the test, or can be restored after the test by the operator.

Product Specific Performance Criteria for xDSL

The particular performance criteria which are specified in the normative annexes of CISPR 35/ EN 55035 take precedence over the corresponding parts of the general performance criteria.

Performance criterion A

Applicable for the test requirement defined in table clause 2.1 of EN 55035

During the swept frequency test the established connection shall be maintained throughout the testing and the information transferred without any additional reproducible errors or loss of synchronisation. If a degradation in performance is observed and the system is adaptive, for example has the capability to automatically retrain in the presence of an interfering signal, then for conducted immunity tests only, the following procedure shall be followed:

- a) For each range of interfering frequencies in which degradation in performance is observed, three frequencies (beginning, middle and end) shall be identified.
- b) At each of the frequencies identified in step a), the interfering signal shall be turned on and the system is allowed to retrain.
- c) If the system is able to retrain and then functions correctly for a dwell time of at least 60 seconds without any additional reproducible errors or loss of synchronisation, then the performance level of the system is considered acceptable.
- d) The frequencies identified in step a) and the data rates achieved in step b) shall be recorded in the test report.

Applicable for the test requirement defined in table clause 2.2 of EN 55035

It is important that the modems are able to train in the presence of repetitive impulsive noise and minimize disruption to

the end-user where a repetitive impulsive noise source starts after the link has synchronized. Therefore the following procedure and performance criteria shall apply.

The manufacturer shall select the class of impulsive noise protection (INP) to be used for the immunity test and should state this information in the technical documentation and in the test report. The maximum delay shall be set to 8 ms.

In the absence of impulsive noise: The modem shall operate without retraining at its target noise margin with a bit rate value depending on the line attenuation and the stationary noise being present on the line. (The actual value will be between the minimum and maximum bit rate values programmed in the port).

The impulsive noise source shall then be applied at the required test level.

With the impulsive noise applied: The modem shall operate without retraining and without SES at the bit rate established prior to the application of the impulsive noise. No extra CRC errors shall occur due to the impulsive noise.

After the test, the noise margin value shall return to the target noise margin.

Performance criterion B

Applicable for the test requirement defined in table clause 2.3 of EN 55035

Modems shall withstand the occurrence of isolated impulsive noise events. The performance criteria defined in below Table shall be applied.

Impulse duration (ms)	Performance criteria
0.24	The application of the impulse shall not cause the xDSL link to lose synchronisation. No CRC errors are permitted.
10	The application of the 5 impulses shall result in less than 75 CRC errors and shall not cause the link to lose synchronisation.
300	The application of the impulse shall not cause the xDSL link to lose synchronisation.

Applicable for the test requirements defined in table clauses 2.5 and 4.5 of EN 55035

For application of this test to the xDSL port, a repetition rate of 100 kHz (burst length 0.75 ms) shall be used.

Degradation of the performance as described in criterion A is permitted in that errors are acceptable during the application of the test. However the application of the test shall not cause the system to lose the established connection or re-train. At the cessation of the test the system shall operate in the condition established prior to the application of the test without user intervention.

After the application of the EFT/B tests to the xDSL or AC mains port, the CRC error count shall not have increased by more than 600 when compared to the count prior to the application of the test.

Performance criterion C

Degradation of the performance as described in criteria A and B is permitted provided that the normal operation of the EUT is self-recoverable to the condition established prior to application of the test or can be restored after the test by the operator.

2.2 Measurement Uncertainty

Where relevant, the following measurement uncertainty levels have been estimated for tests performed on the EUT as specified in CISPR 16-4-2:

Measurement	Expanded Uncertainty (k=2) (±)	Maximum allowable uncertainty (±)
Conducted Emissions from Power Ports	2.94 dB	3.4 dB (U_{cispr})
Conducted Emissions from Wired Network Ports	3.88 dB	5.0 dB (U_{cispr})
Radiated Emissions up to 1 GHz	4.30 dB	6.3 dB (U_{cispr})
Radiated Emissions above 1 GHz	4.96 dB	5.2 dB (U_{cispr})

The other instruments specified are routine verified to remain within the calibrated levels, no measurement uncertainty is required to be calculated.

2.3 Supplementary Information

There is not any deviation from the test standards for the test method, and no modifications required for compliance.

3 General Information

3.1 Description of EUT

Product	Ultra-Compact Embedded System
Brand	Vecow
Test Model	MTC-8010W
Series Model	MTC-8XXXXXXXXXXXXXXXXX (“X” can be 0-9, A-Z or blank for marketing purpose)
Model Difference	For marketing purpose
Sample Status	Engineering sample
Operating Software	Windows 10
Power Supply Rating	DC from Adapter
Accessory Device	N/A
Data Cable Supplied	N/A

Note:

The EUT uses following adapter.

Brand	Seasonic
Model	SSA-0601HE-12
Input Power	100-240Vac, 2A, 50-60Hz
Output Power	12Vdc, 5A
Power Line	AC 3Pin Non-shielded DC cable (1.0m) with one ferrite core.

3.2 Primary Clock Frequencies of Internal Source

The highest frequency generated or used within the EUT or on which the EUT operates or tunes is 1.6GHz, provided by Vecow Co., Ltd., for detailed internal source, please refer to the manufacturer's specifications.

3.3 Features of EUT

1. The tests reported herein were performed according to the method specified by Vecow Co., Ltd., for detailed feature description, please refer to the manufacturer's specifications or user's manual.
2. The EUT configured with the following key components:

Components	Brand	Model	Specification
CPU	Intel	Processor E3950	1.6GHz
RAM	Innodisk	DDD3L 1866 W/T SODIMM	DDR3L 1866, 4GB
SSD	Innodisk	SATA SSD 3MG2-P	64GB

3.4 Operating Modes of EUT and Determination of Worst Case Operating Mode

1. The EUT was pre-tested under operating and standby condition and the worst emission level was found under **operating condition**.
2. The EUT consumed power from AC adapter, which designed with AC power supply of 100-240Vac, 50/60Hz. For radiated emission evaluation, 230Vac/ 50Hz & 110Vac/ 60Hz had been covered during the pre-test. The worst radiated emission data was found at **230Vac/ 50Hz** and recorded in the applied test report.
3. EUT has been pre-tested under following test modes, and test **mode 2** was the worst case for final test.

Mode	Test Condition
1	Lying flat
2	Upright

4. Test modes are presented in the report as below.

Mode	Test Condition	Input Power
Conducted emission test		
2	Full System (Panel: 1280*800, 60Hz + D-Sub: 1920*1200, 60Hz + Display: 3840*2160, 60Hz) + Upright	230Vac/ 50Hz & 110Vac/ 60Hz
Conducted Emissions from Wired network ports test		
2	Full System (Panel: 1280*800, 60Hz + D-Sub: 1920*1200, 60Hz + Display: 3840*2160, 60Hz) + Upright – LAN por 1 (Speed: 1Gbps)	230Vac/ 50Hz
The idle mode of conducted emission test at telecom port was pre-tested based on the worst case of link mode. Due to emissions of idle mode being very low compared to link mode, only the link mode data were presented in the test report.		
Radiated emission test		
2	Full System (Panel: 1280*800, 60Hz + D-Sub: 1920*1200, 60Hz + Display: 3840*2160, 60Hz) + Upright	230Vac/ 50Hz
Harmonics, Flicker, Immunity tests		
2	Full System (Panel: 1280*800, 60Hz + D-Sub: 1920*1200, 60Hz + Display: 3840*2160, 60Hz) + Upright	230Vac/ 50Hz

3.5 Test Program Used and Operation Descriptions

Emission tests (Harmonics & Flicker excluded):

- a. Turned on the power of all equipment.
- b. EUT ran a test program to enable all functions.
- c. EUT read and wrote messages from/to SSD and ext. HDDs.
- d. EUT sent and received messages to/from Notebook PCs (kept in a remote area) via two UTP LAN cables (10m each).
- e. EUT sent “color bars with moving element” messages to panel and ext. LCD Monitors. Then they displayed “color bars with moving element” messages on their screens simultaneously.
- f. Steps c-e were repeated.

Harmonics, Flicker, Immunity tests:

- a. Turned on the power of all equipment.
- b. EUT ran a test program to enable all functions.
- c. EUT read and wrote messages from/to SSD and USB flash disks.
- d. EUT sent and received messages to/from Notebook PCs (kept in a remote area) via two UTP LAN cables (10m each).
- e. EUT sent “color bars” messages to ext. LCD Monitors. Then they displayed “color bars” messages on their screens simultaneously.
- f. Steps c-e were repeated.

3.6 Connection Diagram of EUT and Peripheral Devices

Emission tests (Harmonics & Flicker excluded):

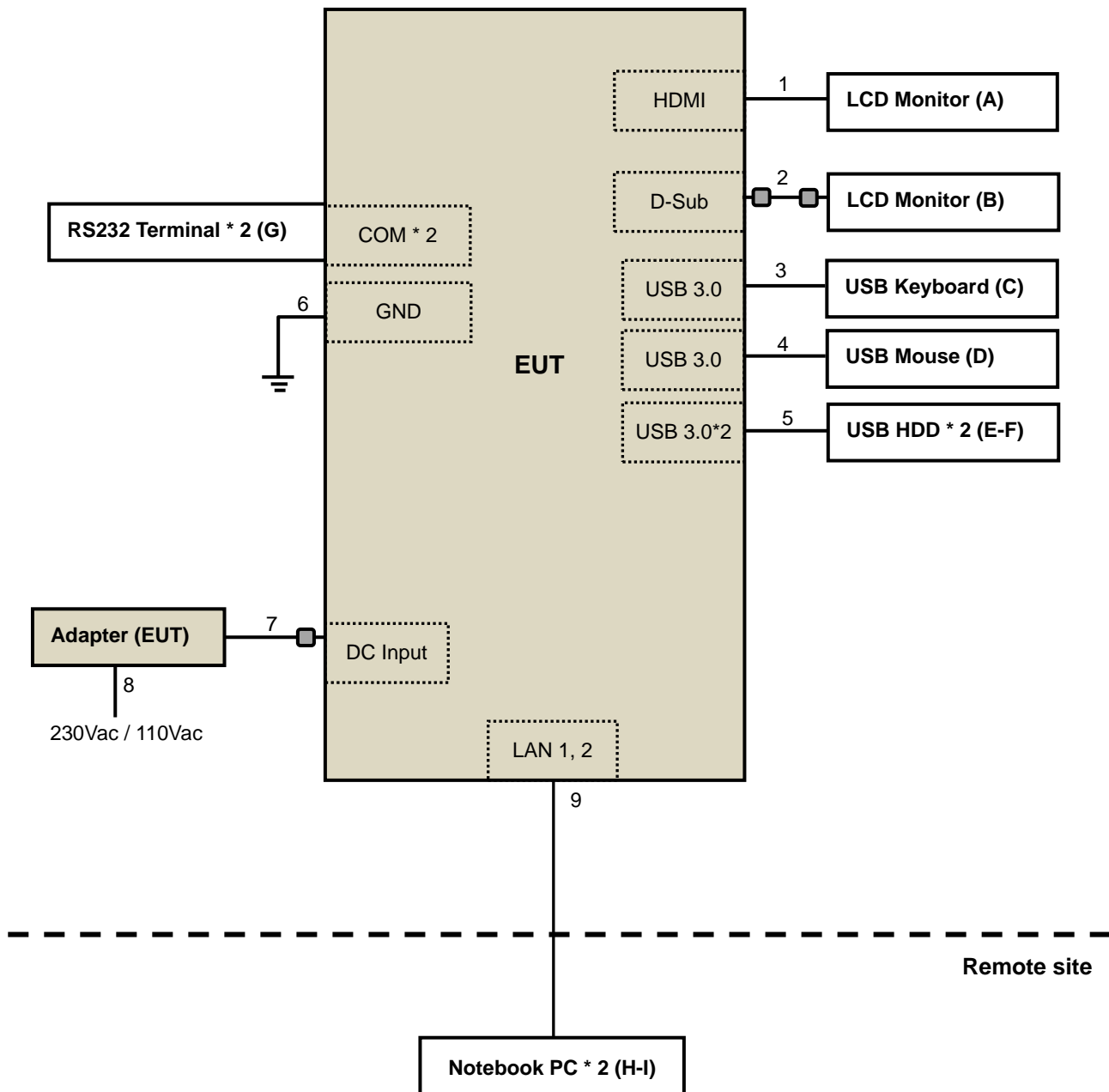

Harmonics & Flicker & Immunity tests:

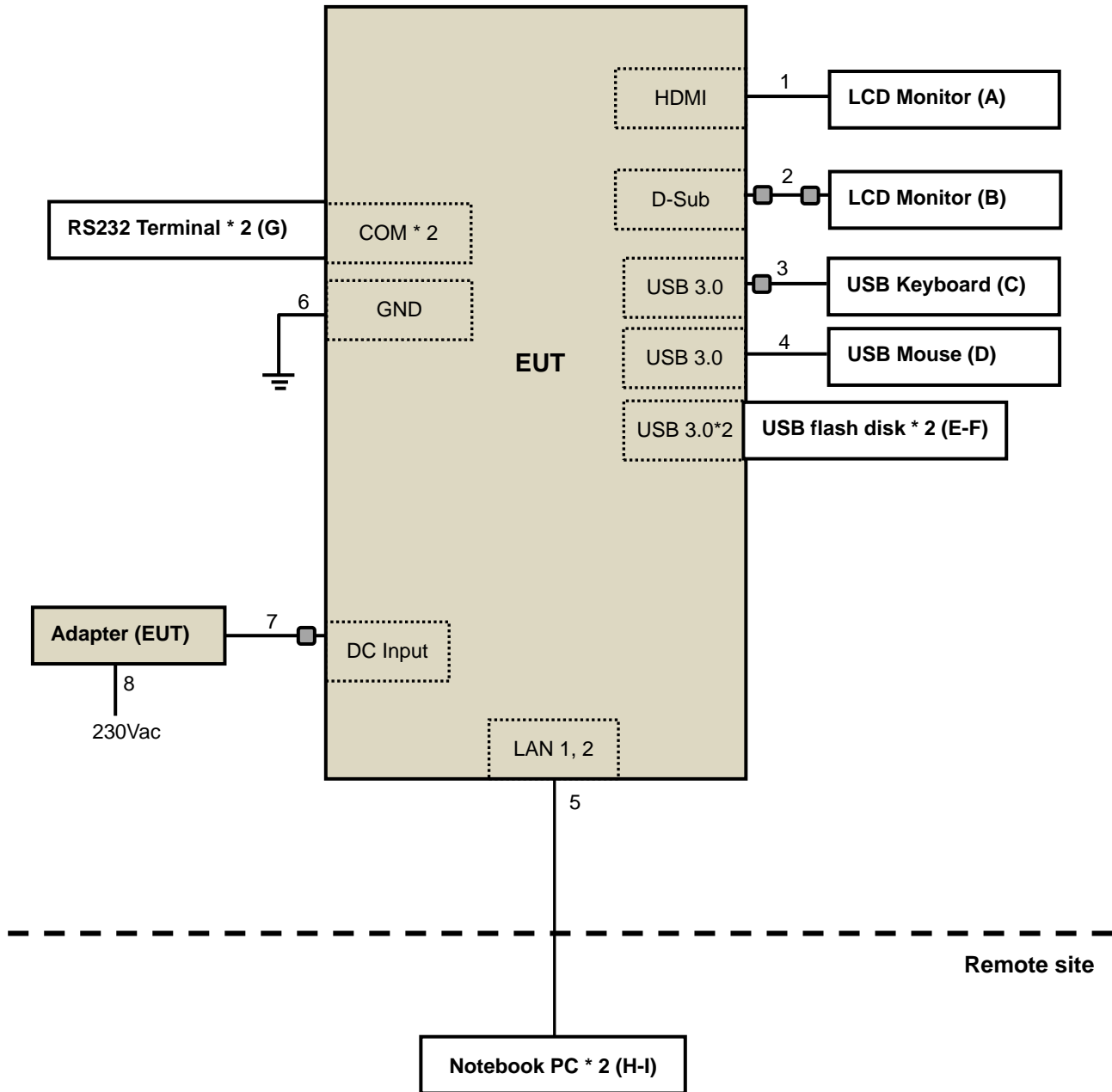

3.7 Configuration of Peripheral Devices and Cable Connections

Emission tests (Harmonics & Flicker excluded):

ID	Product	Brand	Model No.	Serial No.	FCC ID	Remarks
A.	LCD MONITOR	DELL	U2410	CN082WXD728720CC0 KVL	FCC DoC Approved	Provided by Lab
B.	LCD MONITOR	ASUS	MG28UQ	H8LMTF147978	N/A	Provided by Lab
C.	USB Keyboard	Dell	KB216t	CN-0W33XP-LO300-7C L-191E	N/A	Provided by Lab
D.	USB Mouse	DELL	MOCZUL	CN-049TWY-PRC00-77 B-0080	N/A	Provided by Lab
E.	USB 3.0 Hard Disk	WD	WDBUZG0010BBK- PESN	WXM1E1504NEE	FCC DoC Approved	Provided by Lab
F.	USB 3.0 Hard Disk	WD	WDBUZG0010BBK- PESN	WX61A45JRF72	FCC DoC Approved	Provided by Lab
G.	RS232 Terminal* 2	NA	NA	NA	NA	Supplied by client
H.	Notebook PC	ASUS	PU401L	ECNXBC012528528	N/A	Provided by Lab
I.	Notebook PC	SONY	SVS151A12P	275548477001024	N/A	Provided by Lab

Note:

1. All power cords of the above support units are non-shielded (1.8m).
2. Items H-I acted as communication partners to transfer data.

ID	Cable Descriptions	Qty.	Length (m)	Shielding (Yes/No)	Cores (Qty.)	Remarks
1.	HDMI cable	1	2.0	Y	0	Provided by Lab
2.	D-Sub cable	1	1.8	Y	2	Provided by Lab
3.	USB cable	1	1.8	Y	0	Provided by Lab
4.	USB cable	1	1.8	Y	0	Provided by Lab
5.	USB cable	2	1.0	Y	0	Provided by Lab
6.	GND cable	1	1.2	N	0	Provided by Lab
7.	DC power cable	1	1.0	N	1	Supplied by client
8.	AC power cable	1	1.8	N	0	Provided by Lab
9.	LAN cable	2	10	Y	0	Provided by Lab (RJ45, Cat.5e)

Note: The core(s) is(are) originally attached to the cable(s).

Harmonics, Flicker, Immunity tests:

ID	Product	Brand	Model No.	Serial No.	FCC ID	Remarks
A.	24" LCD MONITOR	DELL	U2412M	CN-07N2FG-TV100-7B G-093L	N/A	Provided by Lab
B.	24" LCD MONITOR	DELL	P2418HZM	CN-079XVV-TV200-8BG -00NT	N/A	Provided by Lab
C.	USB Keyboard	DELL	SK-8115	CN-0J4635-71616-63I-0 76F	FCC DoC Approved	Provided by Lab
D.	USB Mouse	DELL	MS116p	CN-0145WW-PRC00-01 D-054P	FCC DoC Approved	Provided by Lab
E.	USB flash disk	HP	X750w	N/A	N/A	Provided by Lab
F.	USB flash disk	HP	X750w	N/A	N/A	Provided by Lab
G.	RS232 Terminal* 2	NA	NA	NA	NA	Supplied by client
H.	Notebook PC	ASUS	PU401L	ECNXBC012528528	N/A	Provided by Lab
I.	Notebook PC	SONY	SVS151A12P	275548477001024	N/A	Provided by Lab

Note:

1. All power cords of the above support units are non-shielded (1.8m).
2. Items H-I acted as communication partners to transfer data.

ID	Cable Descriptions	Qty.	Length (m)	Shielding (Yes/No)	Cores (Qty.)	Remarks
1.	HDMI cable	1	2.0	Y	0	Provided by Lab
2.	D-Sub cable	1	1.8	Y	2	Provided by Lab
3.	USB cable	1	1.1	Y	0	Provided by Lab
4.	USB cable	1	1.8	Y	0	Provided by Lab
5.	LAN cable	2	10	Y	0	Provided by Lab (RJ45, Cat.5e)
6.	GND cable	1	1.2	N	0	Provided by Lab
7.	DC power cable	1	1.0	N	1	Supplied by client
8.	AC power cable	1	1.8	N	0	Provided by Lab

Note: The core(s) is(are) originally attached to the cable(s).

4 Test Instruments

The calibration interval of the all test instruments are 12 months and the calibrations are traceable to NML/ROC and NIST/USA.

4.1 Conducted Emissions from Power Ports

Description & Manufacturer	Model No.	Serial No.	Calibrated Date	Calibrated Until
Test Receiver R&S	ESR3	102413	2021/2/8	2022/2/7
LISN R&S	ESH2-Z5	100104	2020/12/18	2021/12/17
LISN SCHWARZBECK	NNLK8129	8129229	2021/5/20	2022/5/19
DC LISN SCHWARZBECK	NNLK 8121	8121-808	2021/4/18	2022/4/17
LISN SCHWARZBECK	NNLK 8121	8121-731	2021/4/28	2022/4/27
LISN R & S	ESH3-Z5	847265/023	2020/11/11	2021/11/10
LISN R&S	ENV216	101196	2021/4/26	2022/4/25
LISN R&S	ESH3-Z6	844950/018	2021/7/25	2022/7/24
DC LISN R&S	ESH3-Z6	100219	2021/7/25	2022/7/24
RF Coaxial Cable Commate	5D-FB	Cable-CO9-01	2021/8/13	2022/8/12
Attenuator STI	STI02-2200-10	NO.2	2021/8/13	2022/8/12
50 ohms Terminator LYNICS	0900510	E1-01-299	2021/1/27	2022/1/26
Isolation Transformer Erika Fiedler	D-65396	017	2021/9/9	2022/9/8
Software BVADT	Cond_V7.3.7.4	NA	NA	NA

- Note: 1. The test was performed in Linkou Conduction 09.
 2. The VCCI Site Registration No. C-11312.
 3. Tested Date: 2021/9/11

4.2 Conducted Emissions from Wired Network Ports

Description & Manufacturer	Model No.	Serial No.	Cal. Date	Cal. Due
Test Receiver R&S	ESR3	102413	2021/2/8	2022/2/7
LISN R&S	ESH2-Z5	100104	2020/12/18	2021/12/17
LISN SCHWARZBECK	NNLK8129	8129229	2021/5/20	2022/5/19
DC LISN SCHWARZBECK	NNLK 8121	8121-808	2021/4/18	2022/4/17
LISN SCHWARZBECK	NNLK 8121	8121-731	2021/4/28	2022/4/27
LISN R & S	ESH3-Z5	847265/023	2020/11/11	2021/11/10
LISN R&S	ENV216	101196	2021/4/26	2022/4/25
LISN R&S	ESH3-Z6	844950/018	2021/7/25	2022/7/24
DC LISN R&S	ESH3-Z6	100219	2021/7/25	2022/7/24
RF Coaxial Cable Commate	5D-FB	Cable-CO9-01	2021/8/13	2022/8/12
50 ohms Terminator LYNICS	0900510	E1-01-299	2021/1/27	2022/1/26
Isolation Transformer Erika Fiedler	D-65396	017	2021/9/9	2022/9/8
ISN FCC	F-071115-1057-1	20650	2021/2/3	2022/2/2
ISN FCC	F-071115-1057-1	20651	2021/3/10	2022/3/9
ISN FCC	F-071115-1057-1	20652	2021/1/18	2022/1/17
ISN FCC	F-071115-1057-1-09	120033	2021/5/12	2022/5/11
Impedance-stabilization-network TESEQ	ISN T8-Cat6	53159	2021/3/16	2022/3/15
ISN TESEQ	ISN S751	40599	2021/7/27	2022/7/26
ISN TESEQ	ISN ST08	41212	2021/8/8	2022/8/7
Impedance-stabilization-network TESEQ	ISN T400A	28573	2021/8/8	2022/8/7
Impedance-stabilization-network TESEQ	ISN T800	36181	2021/8/6	2022/8/5
RF Current Probe FCC	F-33-4	56	2021/7/27	2022/7/26
Capacitive Voltage Probe FCC	F-CVP-1	82	2021/7/28	2022/7/27
Injection Clamp FCC	FCC-203I	50	NA	NA
Software BVADT	ISN_V7.3.7.4	NA	NA	NA

Note: 1. The test was performed in Linkou Conduction09
 2. The VCCI Site Registration No. C-11312.
 3. Tested Date: 2021/9/11

4.3 Radiated Emissions up to 1 GHz

Description & Manufacturer	Model No.	Serial No.	Calibrated Date	Calibrated Until
TEST RECEIVER R&S	ESCS 30	100292	2021/9/1	2022/8/31
Bi-log Broadband Antenna Schwarzbeck	VULB9168	9168-303	2020/11/5	2021/11/4
Pre_Amplifier HP	8447D	2944A08119	2021/2/18	2022/2/17
RF Coaxial Cable Pacific	8D-FB	Cable-ST2-01	2020/10/23	2021/10/22
Attenuator Mini-Circuits	UNAT-5+	PAD-ST2-01	2020/10/23	2021/10/22
ADT. Turn Table	TT100	0205	NA	NA
ADT. Tower	AT100	0205	NA	NA
Software BVADT	Radiated_V7.6.15.9.5	NA	NA	NA

- Note:
1. The test was performed in Linkou Open Site2 , The test site validated date: 2021/07/30(NSA)
 2. The VCCI Site Registration No. R-10237.
 3. Tested Date: 2021/9/14

4.4 Radiated Emissions above 1 GHz

Description & Manufacturer	Model No.	Serial No.	Calibrated Date	Calibrated Until
Spectrum Analyzer Agilent	E4446A	MY51100009	2021/6/29	2022/6/28
Spectrum Keysight	N9020B	MY60110438	2020/12/2	2021/12/1
Test Receiver Agilent	N9038A	MY50010135	2021/5/28	2022/5/27
Pre-amplifier HP	8449B	3008A01292	2021/2/19	2022/2/18
Pre_Amplifier EMCI	EMC0126545	980076	2021/2/19	2022/2/18
HORN Antenna ETS	3117-PA	00215857	2020/11/22	2021/11/21
Antenna(Horn) EMCO	3115	9312-4192	2020/11/22	2021/11/21
Pre_Amplifier MITEQ	AMF-6F-260400-33-8P	892164	2021/2/19	2022/2/18
Pre_Amplifier EMCI	EMC184045B	980235	2021/2/19	2022/2/18
Antenna(Horn) Schwarzbeck	BBHA-9170	BBHA9170190	2020/11/22	2021/11/21
RF Coaxial Cable HUBER SUHNER	SF-102	Cable-CH7(3.6M)-02	2021/7/8	2022/7/7
Attenuator Mini-Circuits	BW-N4W5+	PAD-CH7-02	2021/7/8	2022/7/7
Attenuator Mini-Circuits	BW-K3-2W44+	PAD-CH7-03	2021/7/8	2022/7/7
BandPass Filter MICRO-TRONICS	BRM17690	005	2021/5/28	2022/5/27
Notch filter MICRO-TRONICS	BRC50703-01	010	2021/5/28	2022/5/27
Turn Table & Tower Max Full	MF7802	MF780208103	NA	NA
Software BVADT	Radiated_V8.7.08	NA	NA	NA

- Note:
1. The test was performed in Linkou 966 Chamber 2 (CH7).
 2. The VCCI Site Registration No. G-10039
 3. Tested Date: 2021/9/13

4.5 Harmonics Current Measurement

Description & Manufacturer	Model No.	Serial No.	Calibrated Date	Calibrated Until
Harmonics and Flicker Analyzer TESEQ	PROFLINE 2105	1632A00983&1639A 01863	2021/6/8	2022/6/7
Software	CTS 4	NA	NA	NA

Note: 1. The test was performed in EMS Room No. 1.
2. Tested Date: 2021/9/17

4.6 Voltage Fluctuations and Flicker Measurement

Description & Manufacturer	Model No.	Serial No.	Calibrated Date	Calibrated Until
Harmonics and Flicker Analyzer TESEQ	PROFLINE 2105	1632A00983&1639A 01863	2021/6/8	2022/6/7
Software	CTS 4	NA	NA	NA

Note: 1. The test was performed in EMS Room No. 1.
2. Tested Date: 2021/9/17

4.7 Electrostatic Discharge (ESD)

Description & Manufacturer	Model No.	Serial No.	Calibrated Date	Calibrated Until
ESD Simulator KeyTek	MZ15/EC	0504259	2020/11/6	2021/11/5
ESD Simulator KeyTek	MZ-15/EC	0401299	2020/10/7	2021/10/6
ESD Simulator TESEQ	NSG 438	1364	2020/12/11	2021/12/10
Electronic Discharge Simulator Noiseken	ESS-2000	ESS0382041	2020/10/7	2021/10/6
ESD Generator EM Test	Dito//DM-150/330//DM-150/330-rfci	P1315117252/P1317117852	2021/7/9	2022/7/8

Note: 1. The test was performed in ESD Room No. 1.
2. Tested Date: 2021/9/17

4.8 Radio Frequency Electromagnetic Field (RS)

Description & Manufacturer	Model No.	Serial No.	Calibrated Date	Calibrated Until
RF Generator TESEQ	ITS 6006	37543	2021/5/19	2022/5/18
Amplifier TESEQ	CBA 1G-150	T44220	NA	NA
Amplifier TESTQ	CBA 3G-050	T44345	NA	NA
Amplifier TESTQ	AS1860-50	S-5944/1	NA	NA
Power Meter BOONTON	4232A	94901	2021/6/16	2022/6/15
Power Sensor BOONTON	51011-EMC	32807	2021/6/16	2022/6/15
RS antenna schwarzbeck mess-elektronik	STLP 9129	9129068	NA	NA
CHANCE MOST Compact Full Anechoic Chamber (7x3x3 m)	NA	NA	2021/1/19	2022/1/18
Software BVADT	RS_V7.6	NA	NA	NA
Audio analyzer R&S	UPV	104565	2021/5/18	2022/5/17
Ear Simulator Telephonometry B&K	4185	2553594	NA	NA
Pressure-field Microphone B&K	2021/1/19	3073929	2021/8/12	2022/8/11
Two channel microphone conditioning amplifier B&K	2690 A OS2	2645274	2021/5/16	2022/5/15
POWER AMPLIFIER B&K	2716C	2610979	NA	NA
Mouth Simulator B&K	4227	2630632	NA	NA
Software BVADT	BV ADT_ABMS_ V7.4.3	NA	NA	NA

Note: 1. The test was performed in Linkou RS1
2. Tested Date: 2021/9/17

4.9 Fast Transients Common Mode (EFT)

Description & Manufacturer	Model No.	Serial No.	Calibrated Date	Calibrated Until
Surge&EFT Generators TESEQ	NSG 3060	1572	2021/4/24	2022/4/23
Burst generator Haefely	PEFT 4010	154954	2021/4/7	2022/4/6

Note: 1. The test was performed in Linkou EFT EMS02
 2. Tested Date: 2021/9/20

4.10 Surge

Description & Manufacturer	Model No.	Serial No.	Calibrated Date	Calibrated Until
Surge&EFT Generators TESEQ	NSG 3060	1572	2021/4/24	2022/4/23
Coupling Decoupling Network EMC-Partner	CDN-UTP8	045	NA	NA
Coupling Decoupling Network TESEQ	CDN HSS-2	41009	NA	NA
Surge Coupling Decoupling Network TESEQ	CDN 118-T8	40386	2021/8/30	2022/8/29
CDN for Unshielded Unsymmetrical Signal & Data Lines TESEQ	CDN117	40144	2021/8/30	2022/8/29

Note: 1. The test was performed in Linkou EMS 02
 2. Tested Date: 2021/9/20

4.11 Radio Frequency Common Mode (CS)

Description & Manufacturer	Model No.	Serial No.	Calibrated Date	Calibrated Until
R&S SML03 S.G R&S	SML03	101801	2021/1/13	2022/1/12
Amplifier AR	75A250AM1	306331	NA	NA
Digital Sweep Function Generator Topward	8120	984801	NA	NA
Power Sensor R & S	NRV-Z5	837878/039	2020/11/10	2021/11/9
Power Meter R & S	NRVD	837794/040	2020/11/10	2021/11/9
FCC EM Injection Clamp FCC	F-203I-23mm	455	NA	NA
Current Clamp FCC	F-120-9A	361	2021/8/8	2022/8/7
Coupling/Dcoupling Network EM TEST	CDN M1/32A	306508	2021/6/17	2022/6/16
CDN M2-16Amp FCC	FCC-801-M2-16A	01047	2021/6/17	2022/6/16
Coupling/Dcoupling Network TESEQ	CDN M232	37702	2021/6/17	2022/6/16
Coupling/Dcoupling Network TESEQ	CDN M332	41258	2021/6/17	2022/6/16
Coupling/Dcoupling Network TESEQ	CDN M332	41256	2021/6/17	2022/6/16
Coupling Decoupling Network TESEQ	CDN M432S	56519	2021/2/25	2022/2/24
CDN FCC	FCC-801-M5-50A	100018	2021/1/19	2022/1/18
Coupling Decoupling Network TESEQ	CDN T2A-10	54942	2021/2/25	2022/2/24
Coupling Decoupling Network TESEQ	CDN T400A	49918	2021/2/25	2022/2/24
Coupling Decoupling Network TESEQ	CDN T800	34428	2021/6/17	2022/6/16
Coupling Decoupling Network TESEQ	CDN T8-10	40376	2021/6/17	2022/6/16
Coupling Decoupling Network TESEQ	CDN T8-230	56641	2021/2/25	2022/2/24
Coupling Decoupling Network TESEQ	CDN T8-230	56642	2021/2/25	2022/2/24
Coupling Decoupling Network TESEQ	CDN T8-230	56643	2021/2/25	2022/2/24
CDN Calibration Kit TESEQ	CDN T8S	29459	2021/6/17	2022/6/16
Coupling Decoupling Network TESEQ	CDN ST08A	56527	2021/2/25	2022/2/24
Coupling Decoupling Network TESEQ	CDN ST08A	56525	2021/2/25	2022/2/24
CDN TESEQ	CDN S200	53490	2021/5/26	2022/5/25
CDN TESEQ	CDN S400	52115	2021/6/17	2022/6/16
Coupling Decoupling Network TESEQ	CDN S751A	56435	2021/2/25	2022/2/24

Coupling Decoupling Network TESEQ	CDN S751A	56436	2021/2/25	2022/2/24
Software BVADT	CS_V7.4.2	NA	NA	NA
Audio analyzer R&S	UPV	104565	2021/5/18	2022/5/17
Ear Simulator Telephonometry B&K	4185	2553594	NA	NA
Pressure-field Microphone B&K	4192	3073928	2021/8/12	2022/8/11
Two channel microphone conditioning amplifier B&K	2690 OS2	3001996	2020/11/25	2021/11/24
POWER AMPLIFIER B&K	2716C	2610979	NA	NA
Mouth Simulator B&K	4227	2630632	NA	NA
Software BVADT	ABMS_V7.4.3	NA	NA	NA

Note: 1. The test was performed in CS Room No. 1.
2. Tested Date: 2021/9/20

4.12 Power Frequency Magnetic Field (PFMF)

Description & Manufacturer	Model No.	Serial No.	Calibrated Date	Calibrated Until
Magnetic Field Test System Haefely Trench AG	MAG 100	083794-06	NA	NA
F.W.BELL 4190 Gaussmeter F.W. Bell	4190	0743043	2021/4/8	2022/4/7

Note: 1. The test was performed in Linkou EMS1
2. Tested Date: 2021/9/17

4.13 Voltage Dips and Interruptions (DIP)

Description & Manufacturer	Model No.	Serial No.	Calibrated Date	Calibrated Until
Harmonics and Flicker Analyzer TESEQ	PROFLINE 2105	1632A00983&1639 A01863	2021/6/8	2022/6/7
EMS Simulator KeyTek	EMCPro	9902207	2021/5/7	2022/5/6
Software	WIN2120	NA	NA	NA

Note: 1. The test was performed in EMS Room No. 1.
2. Tested Date: 2021/9/17

5 Limits of Test Items

For equipment intended to be used exclusively in an industrial environment or a telecommunication centre the class A limits can be used.

5.1 Conducted Emissions from Power Ports

For AC mains power input/output Port

Frequency (MHz)	Class A (dB μ V)		Class B (dB μ V)	
	Quasi-peak	Average	Quasi-peak	Average
0.15 - 0.5	79	66	66 - 56	56 - 46
0.50 - 5.0	73	60	56	46
5.0 - 30.0	73	60	60	50

Notes: 1. The lower limit shall apply at the transition frequencies.

2. The limit decreases linearly with the logarithm of the frequency in the range of 0.15 to 0.50 MHz.

5.2 Conducted Emissions from Wired Network Ports

Class A					
Frequency (MHz)	Coupling Device	Voltage Limit (dBuV)		Current limits (dBuA)	
		Quasi-peak	Average	Quasi-peak	Average
0.15 - 0.5	AAN	97 - 87	84 - 74	-	-
0.5 - 30		87	74	-	-
0.15 - 0.5	CVP and Current probe	97 - 87	84 - 74	53 - 43	40 - 30
0.5 - 30		87	74	43	30
0.15 - 0.5	Current Probe	-	-	53-43	40 - 30
0.5 - 30		-	-	43	30
Class B					
Frequency (MHz)	Coupling Device	Voltage Limit (dBuV)		Current limits (dBuA)	
		Quasi-peak	Average	Quasi-peak	Average
0.15-0.5	AAN	84 - 74	74 - 64	-	-
0.5-30		74	64	-	-
0.15-0.5	CVP and Current probe	84 - 74	74 - 64	40 - 30	30 - 20
0.5-30		74	64	30	20
0.15-0.5	Current Probe	-	-	40 - 30	30 - 20
0.5-30		-	-	30	20

Note: The limits decrease linearly with the logarithm of the frequency in the range 0.15 MHz to 0.5 MHz.

5.3 Radiated Emissions up to 1 GHz

Frequency (MHz)	Class A (dBuV/m)		Class B (dBuV/m)	
	at 3m	at 10m	at 3m	at 10m
30 - 230	50	40	40	30
230 - 1000	57	47	47	37

Notes: 1. The lower limit shall apply at the transition frequencies.

2. Emission level (dBuV/m) = 20 log Emission level (uV/m).

3. All emanations from a class A/B digital device or system, including any network of conductors and apparatus connected thereto, shall not exceed the level of field strengths specified above.

5.4 Radiated Emissions above 1 GHz

Frequency (GHz)	Class A (dBuV/m) (at 3m)		Class B (dBuV/m) (at 3m)	
	Average	Peak	Average	Peak
1 to 3	56	76	50	70
3 to 6	60	80	54	74

- Notes:
1. The lower limit shall apply at the transition frequencies.
 2. Emission level (dBuV/m) = 20 log Emission level (uV/m).
 3. All emanations from a class A/B digital device or system, including any network of conductors and apparatus connected thereto, shall not exceed the level of field strengths specified above.

Frequency Range of Radiated Measurement (For unintentional radiators)

Highest internal frequency (F_x) (MHz)	Highest measurement frequency (F_m) (GHz)
$F_x \leq 108 \text{ MHz}$	1
$108 \text{ MHz} < F_x \leq 500 \text{ MHz}$	2
$500 \text{ MHz} < F_x \leq 1 \text{ GHz}$	5
$F_x > 1 \text{ GHz}$	$5 \times F_x$ up to a maximum of 6 GHz

F_x is the highest fundamental frequency generated and/or used in the ITE or digital apparatus under test.

5.5 Harmonic Current Measurement

Limits for Class A equipment		Limits for Class D equipment		
Harmonic Order n	Max. permissible harmonics current A	Harmonic Order n	Max. permissible harmonics current per watt mA/W	Max. permissible harmonics current A
Odd harmonics		Odd Harmonics only		
3	2.30	3	3.4	2.30
5	1.14	5	1.9	1.14
7	0.77	7	1.0	0.77
9	0.40	9	0.5	0.40
11	0.33	11	0.35	0.33
13	0.21	13	0.30	0.21
$15 \leq n \leq 39$	$0.15 \times 15/n$	$15 \leq n \leq 39$	$3.85/n$	$0.15 \times 15/n$
Even harmonics				
2	1.08			
4	0.43			
6	0.30			
$8 \leq n \leq 40$	$0.23 \times 8/n$			

Note: 1. Class A and Class D are classified according to section 5 of EN 61000-3-2.

1. According to section 7 of EN 61000-3-2, the above limits for all equipment except for lighting equipment having an active input power > 75 W and no limits apply for equipment with an active input power up to and including 75 W.

Classification of equipment

Class A	Class B	Class C	Class D
Balanced three-phase equipment; Household appliances excluding equipment as Class D; Tools excluding portable tools; Dimmers for incandescent lamps; Audio equipment; Equipment not specified in one of the three other classes.	Portable tools; Arc welding equipment which is not professional equipment.	Lighting equipment.	Equipment having a specified power less than or equal to 600 W of the following types: Personal computers and personal computer monitors; Television receivers; Refrigerators and freezers having one or more variable-speed drives to control compressor motor(s).

5.6 Voltage Fluctuations and Flicker Measurement

Test Item	Limit	Note
P_{st}	1.0	P_{st} means short-term flicker indicator.
P_{lt}	0.65	P_{lt} means long-term flicker indicator.
T_{dt} (ms)	500	T_{dt} means maximum time that $d(t)$ exceeds 3.3 %.
d_c (%)	3.3%	d_c means relative steady-state voltage change
d_{max} (%)		d_{max} means maximum relative voltage change. Control Method of Equipment (see below)
	4%	■ - without additional conditions
	6%	□ - switched manually, or - switched automatically more frequently than twice per day, and also has either a delayed restart (the delay not less than a few tens of seconds), or manual restart, after a power supply interruption
	7%	□ - attended whilst in use (for example: hair dryers, vacuum cleaners, kitchen equipment such as mixers, garden equipment such as lawn mowers, portable tools such as electric drills), or switched on automatically, or - is intended to be switched on manually, no more than twice per day, and also has either a delayed restart (the delay being not less than a few tens of seconds) or manual restart, after a power supply interruption.

5.7 General immunity requirements

Port	Basic Standard	Test item	Test specification	Performance criteria	
Power input (AC)	IEC 61000-4-4	Fast Transients, Common Mode (EFT)	±1 kV 5/50 ns (Tr/Th) 5 kHz, repetition frequency	B	
	IEC 61000-4-5	Surge	Line to line: ±1 kV, 1.2/50 µs Line to earth: ±2 kV, 1.2/50 µs	B	
	IEC 61000-4-6	Radio Frequency, Common Mode (CS)	0.15-10 MHz, 3V, 80% AM (1kHz), 10-30 MHz, 3V-1V, 80% AM (1kHz), 30-80 MHz, 1V, 80% AM (1kHz),	A	
	IEC 61000-4-11	Voltage dips and interruptions (DIP)	Voltage Dips: < 5 % residual voltage, 0.5 cycle 70% residual voltage, 25 cycles (at 50Hz) Voltage Interruption: < 5 % residual voltage, 250 cycles (at 50 Hz)	B C C	
DC power/ Wired network and Signal/ Control port	IEC 61000-4-4	Fast Transients Common Mode (EFT)	±0.5 kV 5/50 ns (Tr/Th) 100 kHz, repetition frequency for xDSL port 5 kHz, repetition frequency for other port	B	
	IEC 61000-4-5	Surge	Wired network ports (directly connected to outdoor cables): Symmetrically operated: 10/700µs w/o primary protectors: ±1.0kV, or with primary protectors fitted: ±1.0kV and ±4.0kV, Coaxial or shielded operated: 1.2/50µs shield to ground: ±0.5 kV,	C B B	
			DC power ports (directly connected to outdoor cables): 1.2/50 µs each individual line to earth, or shield to ground: ±0.5 kV,	B	
	IEC 61000-4-6	Broadband impulse noise disturbances (Applicable only to xDSL ports.)	Radio Frequency Common Mode (CS)	0.15-10 MHz, 3V, 80% AM (1kHz), 10-30 MHz, 3V-1V, 80% AM (1kHz), 30-80 MHz, 1V, 80% AM (1kHz),	A
			Repetitive : Impulse frequency profile : 0.15 – 0.5 MHz, 107 dBuV ; 0.5 – 10 MHz, 107 – 36 dBuV ; 10 – 30 MHz, 36 – 30 dBuV Burst duration : 0.70 ms Burst period :10 ms(for 50 Hz) At least 2 minutes for each port under test. Isolated : Impulse frequency profile : 0.15 –30 MHz, 110 dBuV Burst duration : 0.24 ms, 10 ms and 300 ms Isolated impulses : 5 times Interval : at least 60 seconds	A B	

Port	Basic Standard	Test item	Test specification	Performance criteria
Enclosure	IEC 61000-4-2	Electrostatic Discharge (ESD)	±4 kV (contact) ±8 kV (Air)	B
	IEC 61000-4-3	Radio Frequency Electromagnetic Field (RS)	Swept Frequency Test: 80 to 1000(MHz), 3 V/m, 80 % AM (1 kHz) Spot Frequency Test: 1800, 2600, 3500, 5000 MHz (±1 %), 3V/m, 80% AM (1kHz)	A
	IEC 61000-4-8	Power Frequency Magnetic Field (PFMF)	1A/m, 50Hz	A

6.2 Conducted Emissions from Wired Network Ports

Method of Using AANs:

- The EUT is placed 0.4 meters from the conducting wall of the shielded room and connected to AAN directly to reference ground plane.
- If voltage measurement is used, measure voltage at the measurement port of the AAN, correct the reading by adding the AAN voltage division factor, and compare to the voltage limit.
- It is not necessary to apply the current limit if a AAN is used.
- The test results of disturbance at telecommunication ports are recorded of six worst margins for quasi-peak (mandatory) [and average (if necessary)] values against the limits at frequencies of interest unless the margin is 20 dB or greater.

Note: The resolution bandwidth and video bandwidth of test receiver is 9kHz for quasi-peak detection (QP) and average detection (AV) at frequency 0.15MHz-30MHz.

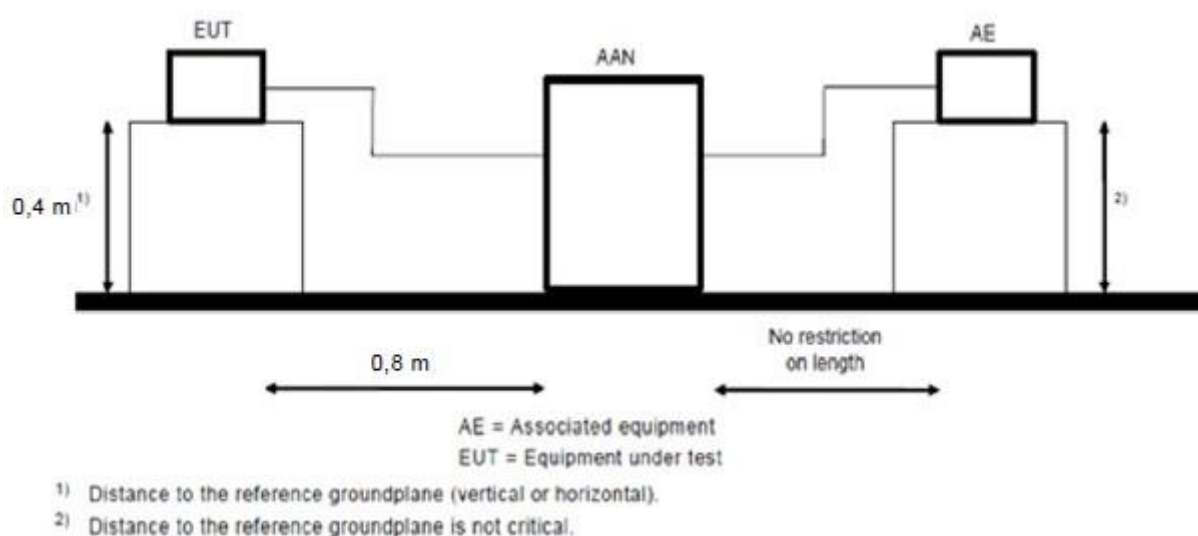

For the actual test configuration, please refer to the related Item – Photographs of the Test Configuration.

Method of Using a 150 Ω load to the outside surface of the shielding cable:

- a. Breaks the external protective insulation (exposing the shield) and connect a 150Ω resistor from the outside surface of the shield to ground.
- b. A current probe shall be placed at 0.1 m from the 150Ω resistor. The current probe to EUT horizontal distance is between 0.3 m to 0.8 m.
- c. If current measurement is used, measure current at the measurement port of the current probe, correct the reading by adding the current probe division factor, and compare to the current limit.
- d. It is not necessary to apply the voltage limit if a current probe is used.
- e. The test results of disturbance at telecommunication ports are recorded of six worst margins for quasi-peak (mandatory) [and average (if necessary)] values against the limits at frequencies of interest unless the margin is 20 dB or greater.

Note: The resolution bandwidth and video bandwidth of test receiver is 9kHz for quasi-peak detection (QP) and average detection (AV) at frequency 0.15MHz-30MHz.

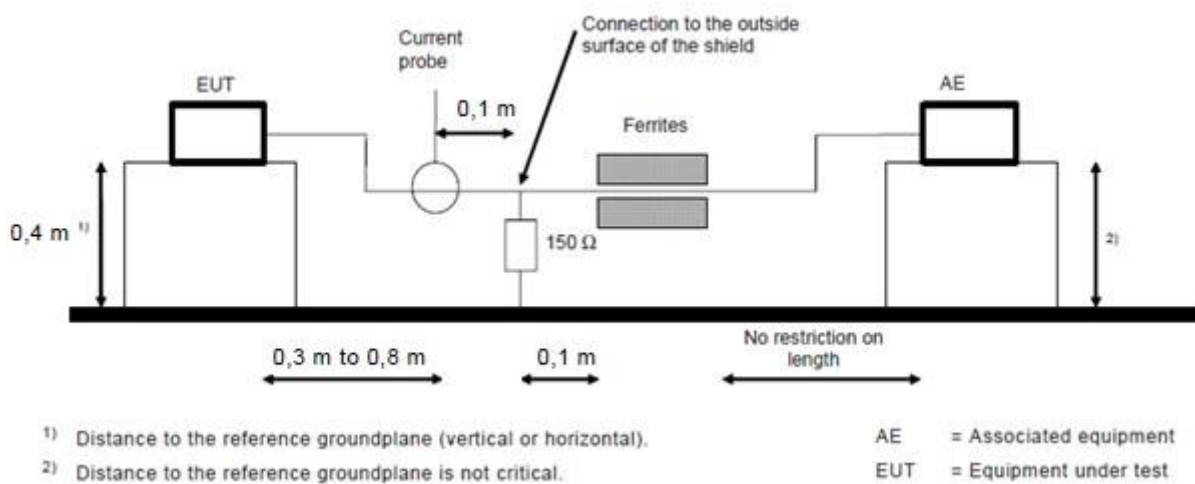

For the actual test configuration, please refer to the related Item – Photographs of the Test Configuration.

Method of Using a combination of current probe and capacitive voltage probe:

- a. Measure current with a current probe.
- b. Compare the measured current with the applicable current limit.
- c. Measure voltage with a capacitive voltage probe as specified in 5.2.2 of CISPR 16-1-2.
- d. Adjust the measured voltage as follows:
 - current margin ≤ 6 dB – subtract the actual current margin from measured voltage;
 - current margin > 6 dB – subtract 6 dB from measured voltage.
- e. Compare adjusted voltage with the applicable voltage limit
- f. Both the measured current and the adjusted voltage shall be below the applicable
- g. The test results of disturbance at telecommunication ports are recorded of six worst margins for quasi-peak (mandatory) [and average (if necessary)] values against the limits at frequencies of interest unless the margin is 20 dB or greater.

Note: The resolution bandwidth and video bandwidth of test receiver is 9kHz for quasi-peak detection (QP) and average detection (AV) at frequency 0.15MHz-30MHz.

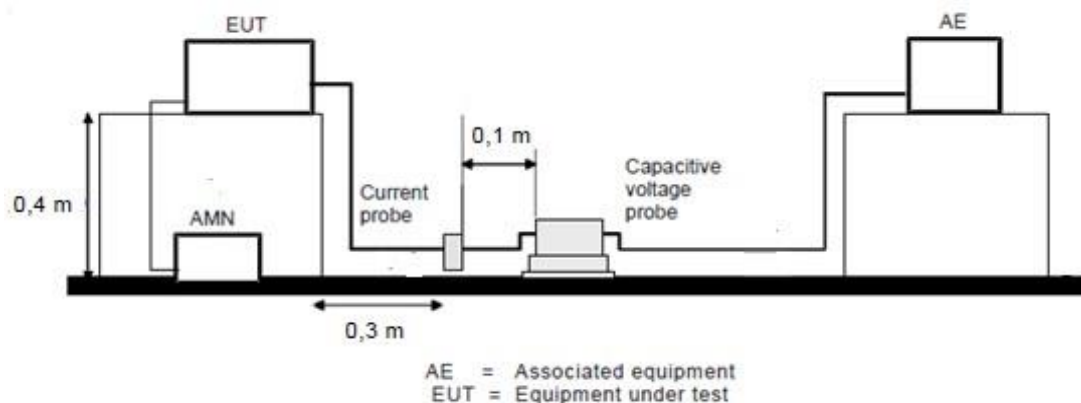

For the actual test configuration, please refer to the related Item – Photographs of the Test Configuration.

6.3 Radiated Emissions up to 1 GHz

- For the table-top EUT is placed on a 0.8 meter to the top of rotating table; for the the floor standing EUT shall be insulated (by insulation of maximum thickness of 150 mm) from the horizontal reference ground plane. The rotating table is rotated 360 degrees to determine the position of the highest radiation. If the equipment requires a dedicated ground connection, this shall be provided and bonded to the RGP.
- The EUT is set 10 meters away from the interference-receiving antenna, which is mounted on the top of a variable-height antenna tower.
- The antenna is a broadband antenna, and its height is varied from one meter to four meters above the ground to determine the maximum value of the field strength. Both horizontal and vertical polarizations of the antenna are set to make the measurement.
- For each suspected emission, the EUT is arranged to its worst case and then the antenna is tuned to heights from 1 m to 4 m and the rotatable table was turned from 0 degrees to 360 degrees to find the maximum reading.
- The test-receiver system is set to quasi-peak detect function and specified bandwidth with maximum hold mode when the test frequency is up to 1 GHz.

Note: The resolution bandwidth and video bandwidth of test receiver/spectrum analyzer is 120kHz for quasi-peak detection (QP) at frequency up to 1GHz.

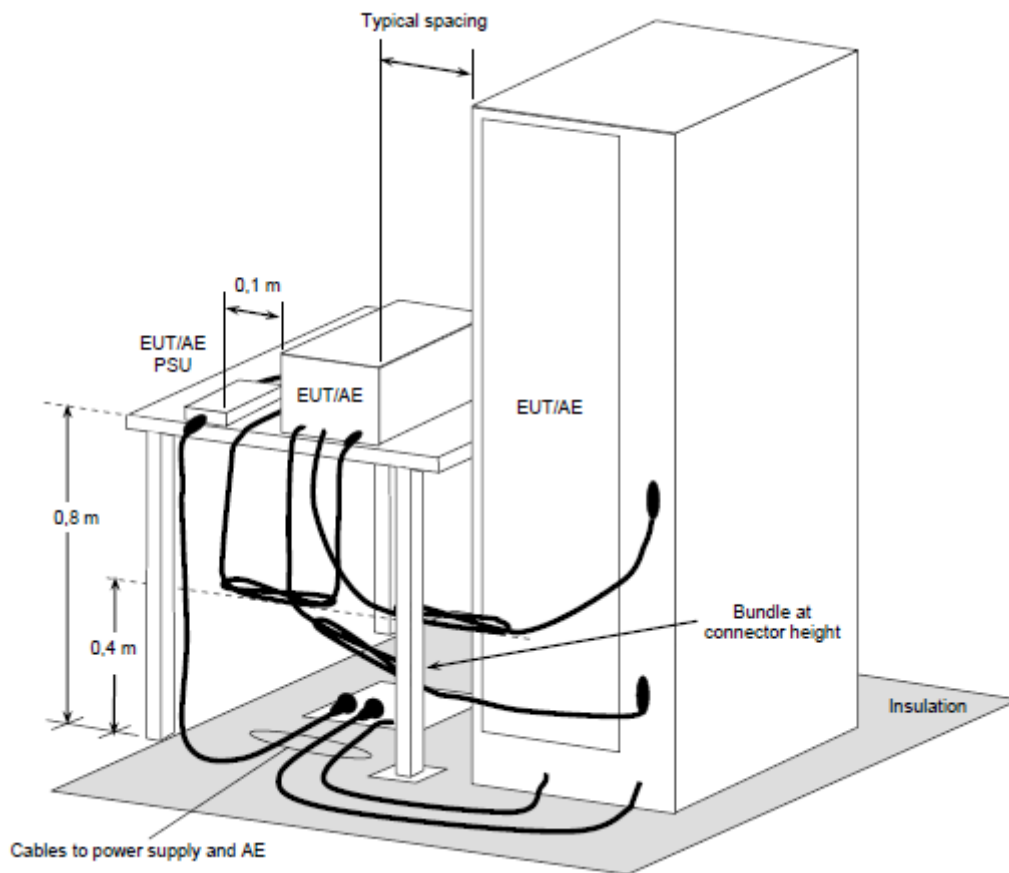

For the actual test configuration, please refer to the related Item – Photographs of the Test Configuration.

6.4 Radiated Emissions above 1 GHz

- For the table-top EUT is placed on a 0.8 meter to the top of rotating table; for the the floor standing EUT shall be insulated (by insulation of maximum thickness of 150 mm) from the horizontal reference ground plane. The rotating table is rotated 360 degrees to determine the position of the highest radiation. If the equipment requires a dedicated ground connection, this shall be provided and bonded to the RGP.
- The EUT was set $d = 3$ meters away from the interference-receiving antenna, which was mounted on the top of a variable-height antenna tower.
- The height of antenna can be varied from one meter to four meters, the height of adjustment depends on the EUT height and the antenna 3dB beamwidth both, to detect the maximum value of the field strength. Both horizontal and vertical polarizations of the antenna are set to make the measurement.
- For each suspected emission, the EUT was arranged to its worst case and then the antenna was tuned to heights and the rotatable table was turned from 0 degrees to 360 degrees to find the maximum reading.
- The spectrum analyzer system was set to peak and average detects function and specified bandwidth with maximum hold mode when the test frequency is above 1 GHz.

Note: The resolution bandwidth of test receiver/spectrum analyzer is 1MHz and video bandwidth is 3MHz for Peak detection (PK) at frequency above 1GHz. The resolution bandwidth of test receiver/spectrum analyzer is 1 MHz for Average detection (AV) at frequency above 1GHz.

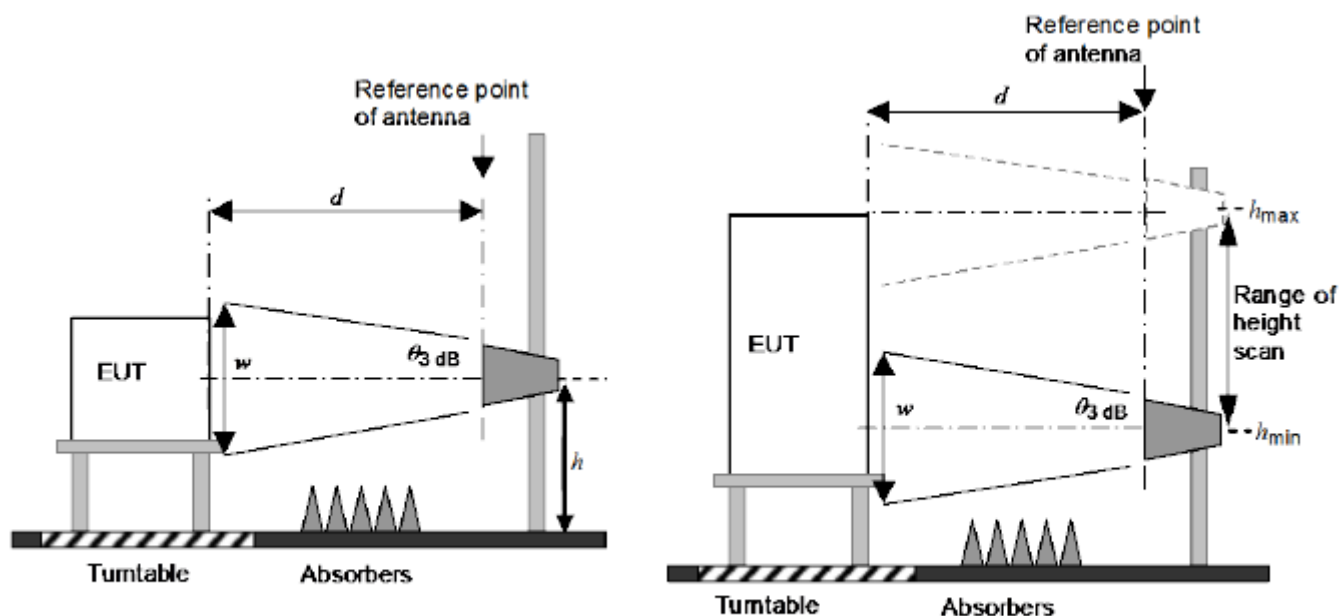

a) w encompasses EUT height
(fixed-height measurement)

b) w does not encompass EUT height
(height scan required)

For the actual test configuration, please refer to the related Item – Photographs of the Test Configuration.

6.5 Harmonics Current Measurement

- The harmonic current limits apply to line currents and not to currents in the neutral conductor. Nevertheless, for single-phase equipment, it is permissible to measure the currents in the neutral conductor instead of the currents in the line.
- The EUT is tested as presented by, and in accordance with information provided by, the manufacturer. Preliminary operation of motor drives by the manufacturer may be needed before the tests are undertaken to ensure that results correspond with normal use.
- In all configurations, the use of additional load shall not cause the total output power available to be exceeded.
- The correspondent test program of test instrument to measure the current harmonics emanated from EUT is chosen. The measure time shall be not less than the time necessary for the EUT to be exercised.

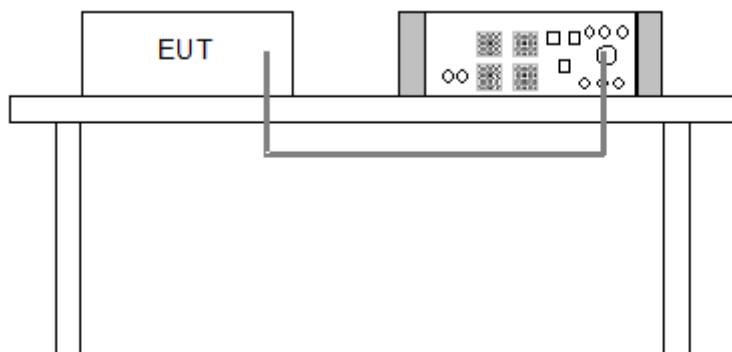

For the actual test configuration, please refer to the related Item – Photographs of the Test Configuration.

6.6 Voltage Fluctuations and Flicker Measurement

- Controls or automatic programs of the EUT shall be set to produce the most unfavourable sequence of voltage changes, using only those combinations of controls and programmes which are mentioned by the manufacturer in the instruction manual, or are otherwise likely to be used.
- Preliminary operation of motor drives may be needed before the tests to ensure that results corresponding to those of normal use are obtained.
- During the flick measurement, the measure time shall include that part of whole operation cycle in which the EUT produce the most unfavorable sequence of voltage changes. The observation period for short-term flicker indicator is 10 minutes and the observation period for long-term flicker indicator is 2 hours.

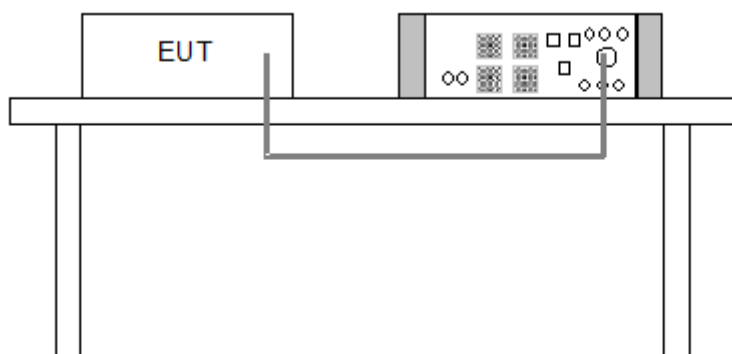

For the actual test configuration, please refer to the related Item – Photographs of the Test Configuration.

6.7 Electrostatic Discharge (ESD)

Discharge Impedance:	330 ohm / 150 pF
Number of Discharge:	Air – Direct: 10 discharges per location (each polarity) Contact – Direct & Indirect: 10 discharges per location (each polarity)
Discharge Period:	1-second minimum

The basic test procedure was in accordance with EN/IEC 61000-4-2:

- a. Electrostatic discharges were applied only to those points and surfaces of the EUT that are accessible to users during normal operation.
- b. The test was performed with at least ten single discharges on the pre-selected points in the most sensitive polarity.
- c. The time interval between two successive single discharges was at least 1 second.
- d. The ESD generator was held perpendicularly to the surface to which the discharge was applied and the return cable was at least 0.2 meters from the EUT.
- e. Contact discharges were applied to the non-insulating coating, with the pointed tip of the generator penetrating the coating and contacting the conducting substrate.
- f. Air discharges were applied with the round discharge tip of the discharge electrode approaching the EUT as fast as possible (without causing mechanical damage) to touch the EUT. After each discharge, the ESD generator was removed from the EUT and re-triggered for a new single discharge. The test was repeated until all discharges were complete.
- g. At least ten single discharges (in the most sensitive polarity) were applied to the **Horizontal Coupling Plane** at points on each side of the EUT. The ESD generator was positioned at a distance of 0.1 meters from the EUT with the discharge electrode touching the **HCP**.
- h. At least ten single discharges (in the most sensitive polarity) were applied to the center of one vertical edge of the **Vertical Coupling Plane** in sufficiently different positions that the four faces of the EUT were completely illuminated. The **VCP** (dimensions 0.5m x 0.5m) was placed vertically to and 0.1 meters from the EUT.

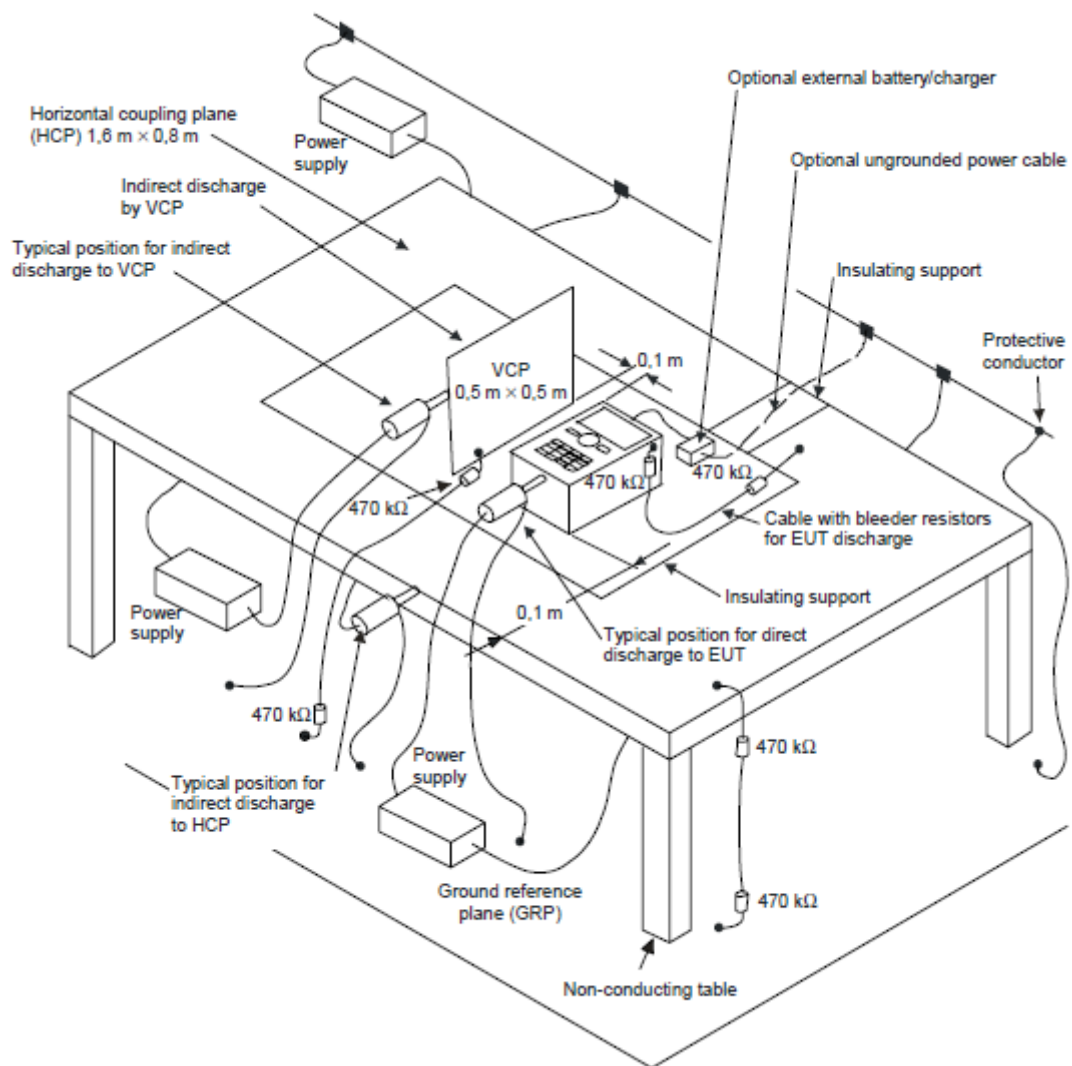

For the actual test configuration, please refer to the related item – Photographs of the Test Configuration.

NOTE:

TABLE-TOP EQUIPMENT

The configuration consisted of a wooden table 0.8 meters high standing on the **Ground Reference Plane**. The **GRP** consisted of a sheet of aluminum at least 0.25mm thick, and 2.5 meters square connected to the protective grounding system. A **Horizontal Coupling Plane** (1.6m x 0.8m) was placed on the table and attached to the **GRP** by means of a cable with 940kΩ total impedance. The equipment under test, was installed in a representative system as described in section 7 of EN/IEC 61000-4-2, and its cables were placed on the **HCP** and isolated by an insulating support of 0.5mm thickness. A distance of 1-meter minimum was provided between the EUT and the walls of the laboratory and any other metallic structure.

FLOOR-STANDING EQUIPMENT

The equipment under test was installed in a representative system as described in section 7 of IEC 61000-4-2, and its cables were isolated from the Ground Reference Plane by an insulating support of 0.1-meter thickness. The GRP consisted of a sheet of aluminum that is at least 0.25mm thick, and 2.5 meters square connected to the protective grounding system and extended at least 0.5 m

6.8 Radio Frequency Electromagnetic Field (RS)

Modulation:	1kHz Sine Wave, 80%, AM Modulation
Frequency Step:	1 % of preceding frequency value
Dwell Time:	3 seconds

The test procedure was in accordance with EN/IEC 61000-4-3.

- The testing was performed in a modified semi-anechoic chamber.
- The frequency range shall be swept, with the signal 80% amplitude modulated with a 1kHz sine wave.
- The test was performed with the EUT exposed to both vertically and horizontally polarized fields on each of the four sides.

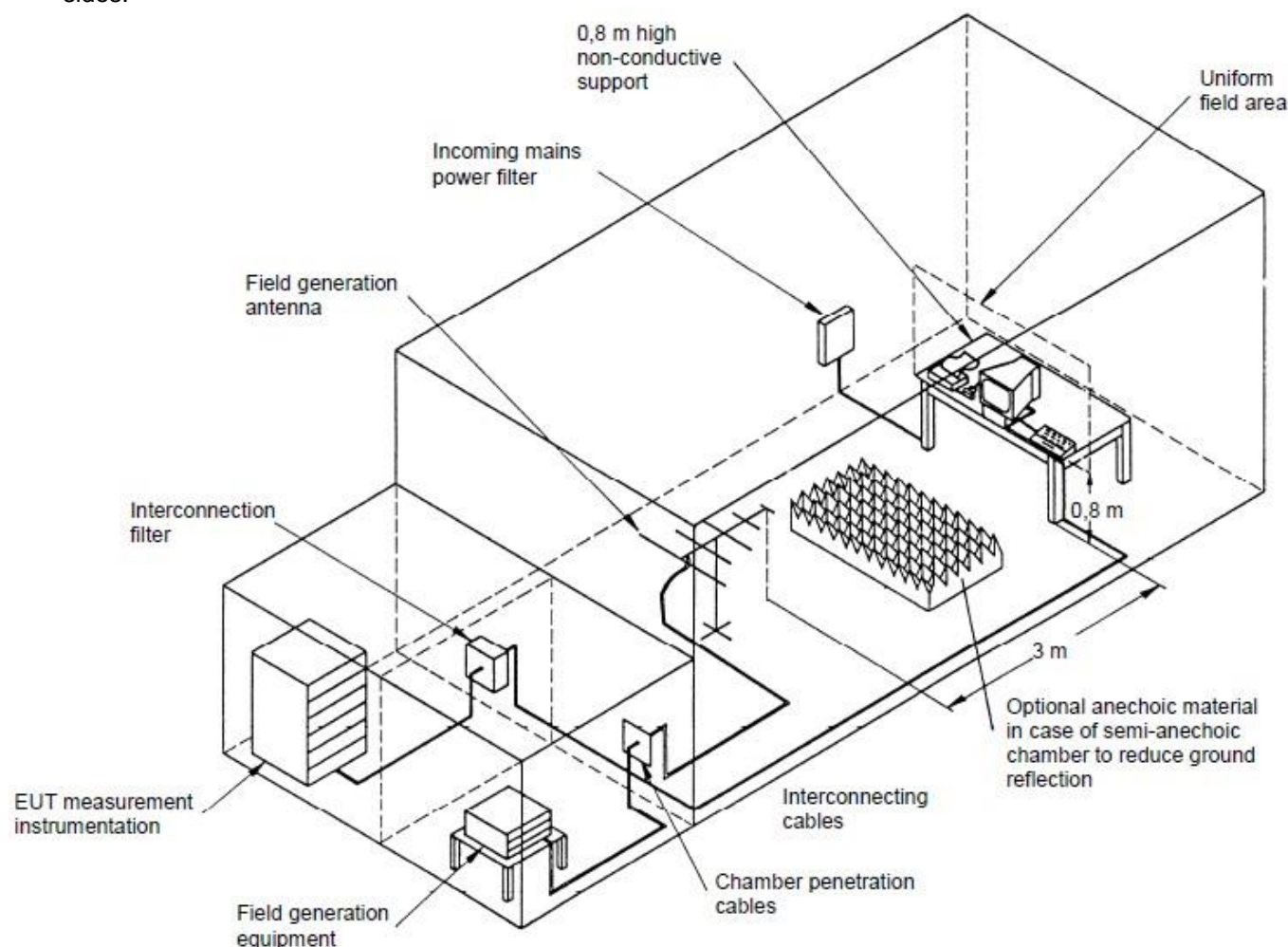

For the actual test configuration, please refer to the related item – Photographs of the Test Configuration.

NOTE:

TABLETOP EQUIPMENT

The EUT installed in a representative system as described in section 7 of EN/IEC 61000-4-3 was placed on a non-conductive table 0.8 meters in height. The system under test was connected to the power and signal wire according to relevant installation instructions.

FLOOR STANDING EQUIPMENT

The EUT installed in a representative system as described in section 7 of EN/IEC 61000-4-3 was placed on a non-conductive wood support 0.1 meters in height. The system under test was connected to the power and signal wire according to relevant installation instructions.

6.9 Fast Transients Common Mode (EFT)

Impulse Repetition Frequency:	xDSL telecommunication port: 100kHz others: 5kHz
Impulse Wave Shape:	5/50 ns
Burst Duration:	0.75 ms for 100kHz Repetition Frequency 15 ms for 5kHz Repetition Frequency
Burst Period:	300 ms
Test Duration:	1 min.

- Both positive and negative polarity discharges were applied.
- The distance between any coupling devices and the EUT should be 0.5 m for table-top equipment testing, and 1.0 m for floor standing equipment.
- The duration time of each test sequential was 1 minute.
- The transient/burst waveform was in accordance with EN/IEC 61000-4-4, 5/50 ns.

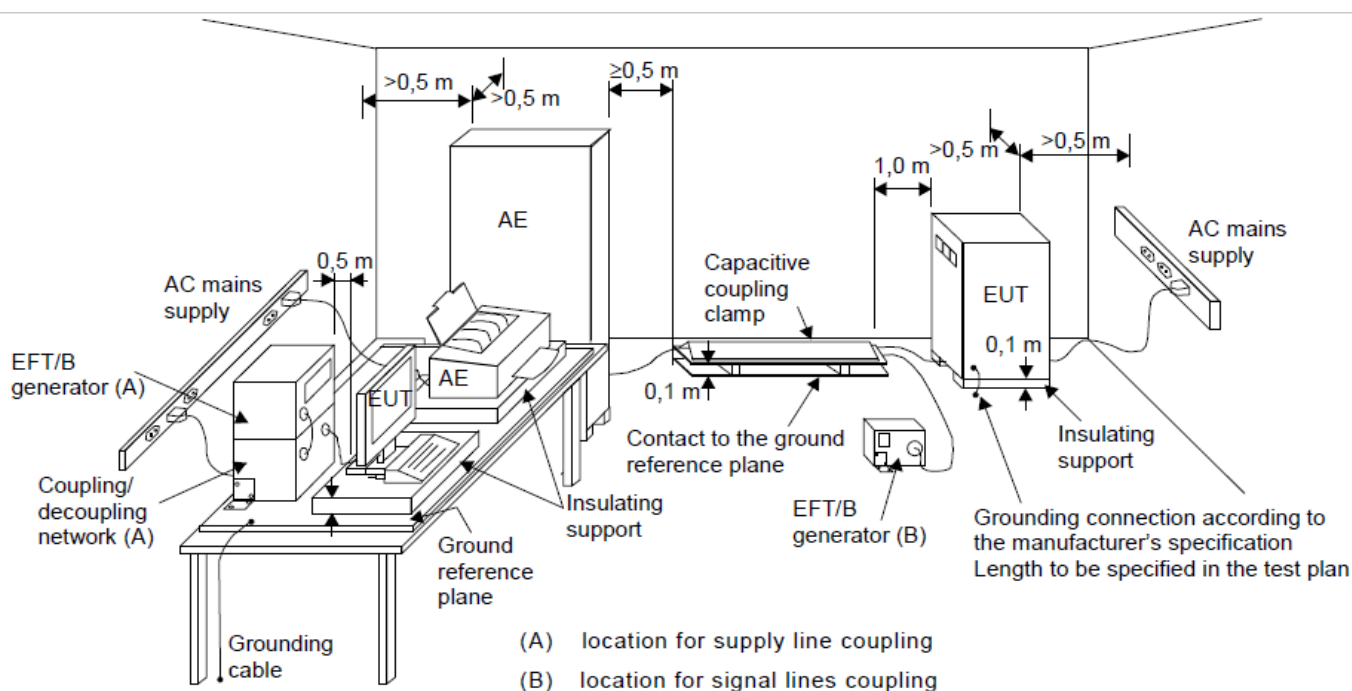

For the actual test configuration, please refer to the related item – Photographs of the Test Configuration.

6.10 Surge

Pulse Repetition Rate:	20 sec.
Number of Tests:	5 positive and 5 negative at selected points

a. EUT Power ports:

The surge shall be applied to the EUT power supply terminals via the capacitive coupling network. Decoupling networks are required in order to avoid possible adverse effects on equipment not under test that may be powered by the same lines and to provide sufficient decoupling impedance to the surge wave. The power cord between the EUT and the coupling network shall not exceed 2 meters in length.

For double-insulated products without PE or external earth connections, the test shall be done in a similar way as for grounded products but without adding any additional external grounded connections. If there are no other possible connections to earth, line-to-ground tests may be omitted.

b. Wired network ports

- Unshielded unsymmetrical interconnection lines:

The coupling / decoupling networks shall not influence the specified functional conditions of the EUT. The interconnection line between the EUT and the coupling network shall not exceed 2 meters in length.

No line-to-ground surges are applied for double-insulated products (i.e. products without any dedicated earth terminal).

- Unshielded symmetrical interconnection lines:

For symmetrical interconnection lines and high-speed interconnection lines, the CDN shall be selected to match the number of lines/pairs existing the cable. If coupling arrestors are use, test levels below the ignition point of the coupling arrestor cannot be specified.

The interconnection line between the EUT and the coupling/decoupling networks shall not exceed 2 meters in length.

In order to avoid the coupling and decoupling capacitors having a filtering effect on the data transfer, a balanced high frequency design associating the coupling capacitors with coupling chokes is required. Where normal functioning of high speed communications lines cannot be achieved because of the impact of the CDN on the EUT, product committees should specify appropriate operation or that no surge immunity test is required.

- Shielded lines:

The EUT is isolated from ground and the surge is applied to its metallic enclosure; the termination (or auxiliary equipment) at the port(s) under test is grounded. This test applies to equipment with one or more shielded cables.

The length of the cable between the port(s) under test and the device attached to the other end of the cable (AE in Figure 12) shall be:

- 20 m (preferred length) or,
- the shortest length over 10 m, where the manufacturer provides pre-assembled cables used in actual installations.

No test shall be required for cables which according to the manufacturer's specification are ≤ 10 m.

Rules for application of the surge to shielded lines:

- a) Shields grounded at both ends:
 - the test shall be carried out.

The test level is applied on shields with a 2Ω generator source impedance and with the $18 \mu\text{F}$ capacitor.

- b) Shields grounded at one end:
 - the test shall be carried out according to unshielded unsymmetrical interconnection lines or unshielded symmetrical interconnection lines because the shield does not provide any protection against surges induced by magnetic fields.

For EUTs which do not have metallic enclosures, the surge is applied directly to the shielded cable at the EUT side.

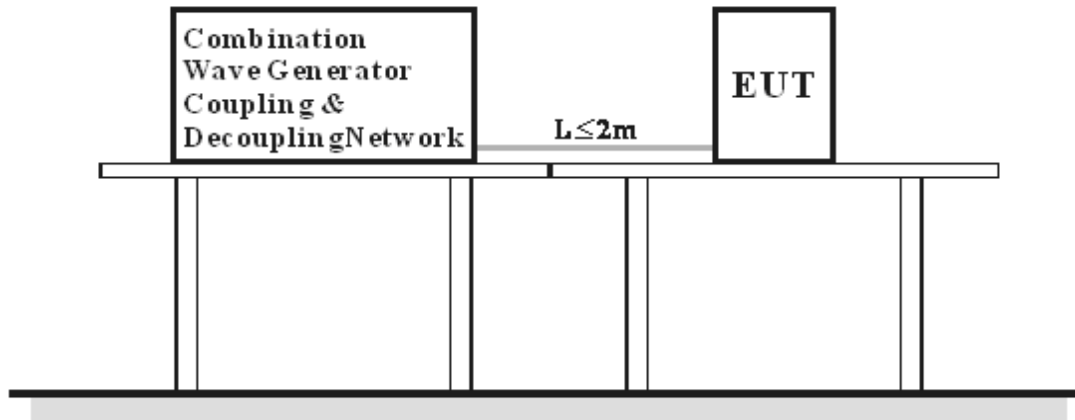

For the actual test configuration, please refer to the related item – Photographs of the Test Configuration.

6.11 Radio Frequency Common Mode (CS)

Modulation:	1kHz Sine Wave, 80%, AM Modulation
Frequency Step:	1 % of preceding frequency value
Dwell Time	3 seconds

- The EUT shall be tested within its intended operating and climatic conditions.
- An artificial hand was placed on the hand-held accessory and connected to the ground reference plane.
- One of the CDNs not used for injection was terminated with 50 ohm, providing only one return path. All other CDNs were coupled as decoupling networks.
- The frequency range shall be swept, using the signal level established during the setting process and with a disturbance signal of 80 % amplitude. The signal is modulated with a 1 kHz sine wave, pausing to adjust the RF signal level or the switch coupling devices as necessary. Where the frequency is swept incrementally, the step size shall not exceed 1 % of the preceding frequency value.
- Attempts should be made to fully exercise the EUT during testing, and to fully interrogate all exercise modes selected for susceptibility.

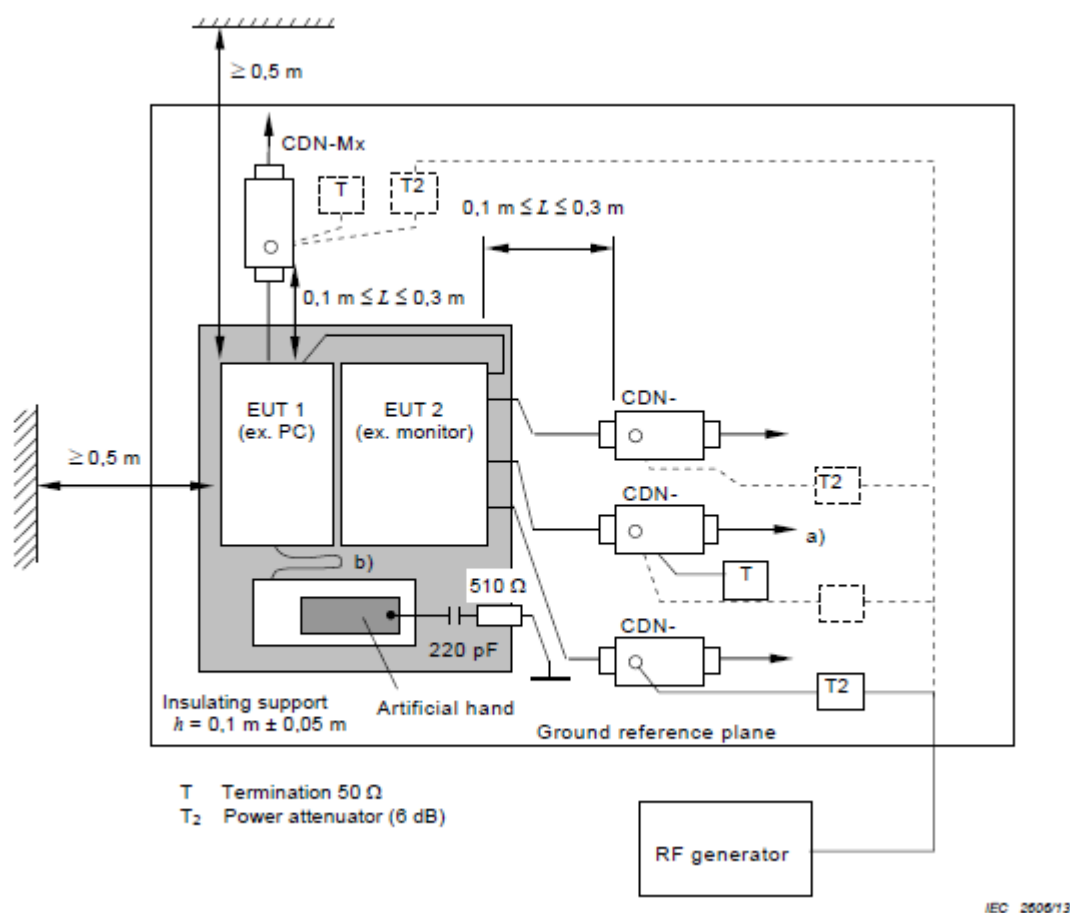

Note: 1. The EUT clearance from any metallic obstacles shall be at least 0,5 m.
2. Interconnecting cables (≤ 1 m) belonging to the EUT shall remain on the insulating support.
For the actual test configuration, please refer to the related item – Photographs of the Test Configuration.

Broadband impulse noise disturbances, Repetitive and Isolated (Applicable only to xDSL ports.)

- a. The EUT shall be tested within its intended operating and climatic conditions.
- b. An artificial hand was placed on the hand-held accessory and connected to the ground reference plane.
- c. One of the CDNs not used for injection was terminated with 50 ohm, providing only one return path. All other CDNs were coupled as decoupling networks.
- d. For the repetitive impulse test the disturbance shall be applied for a period of at least 2 minutes for each port under test.
- e. For the isolated impulse test a minimum of 5 isolated impulses shall be applied with an interval of at least 60 seconds between successive impulses.
- f. Attempts should be made to fully exercise the EUT during testing, and to fully interrogate all exercise modes selected for susceptibility.

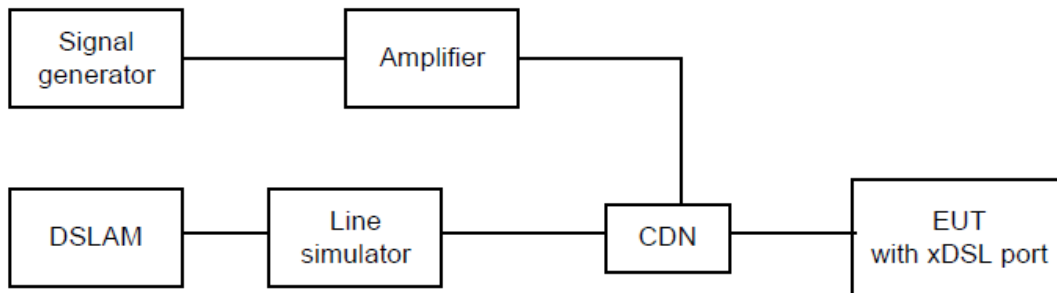

Example schematic of the broadband impulsive conducted disturbances test setup

For the actual test configuration, please refer to the related item – Photographs of the Test Configuration.

6.12 Power Frequency Magnetic Field (PFMF)

Observation Time:	1 minute
Inductance Coil:	Rectangular coil, 1 m x 1 m (L x W)

- The equipment is configured and connected to satisfy its functional requirements.
- The power supply, input and output circuits shall be connected to the sources of power supply, control and signal.
- The cables supplied or recommended by the equipment manufacturer shall be used. 1 meter of all cables used shall be exposed to the magnetic field.

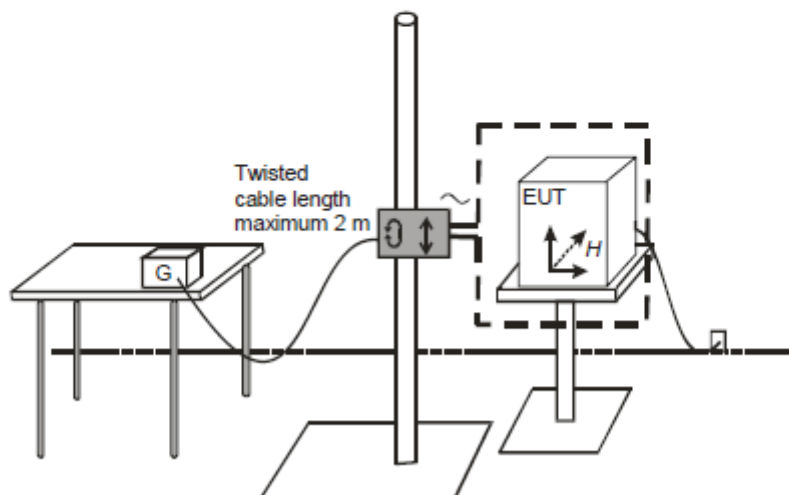
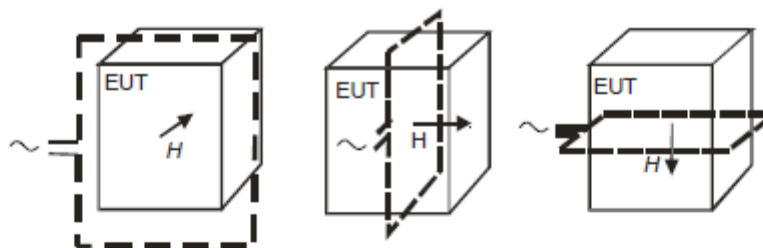

For the actual test configuration, please refer to the related item – Photographs of the Test Configuration.

6.13 Voltage Dips and Interruptions (DIP)

Interval between Event:	10 seconds
Sync Angle (degrees):	0° / 180°
Test Cycle:	3 times

- The test shall be performed with the EUT connected to the test generator with the shortest power supply cable as specified by the EUT manufacturer. If no cable length is specified, it shall be the shortest possible length suitable to the application of the EUT.
- The EUT shall be tested for each selected combination of test levels and duration with a sequence of 3 dips/interruptions with intervals of 10 s minimum (between each test event). Each representative mode of operation shall be tested. Abrupt changes in supply voltage shall occur at 0 voltage crossover point of the voltage waveform.

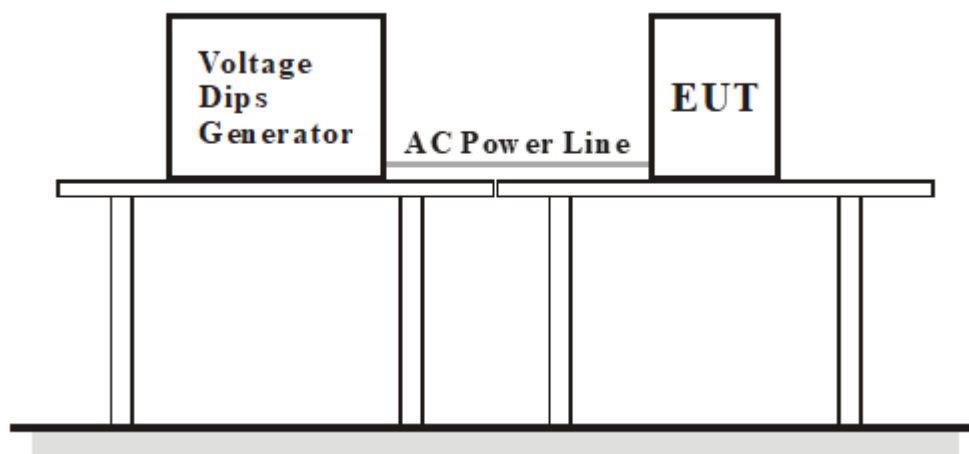

For the actual test configuration, please refer to the related item – Photographs of the Test Configuration.

7 Test Results

7.1 Conducted emissions from Power Ports

Mode 2

Frequency Range	150kHz ~ 30MHz	Detector Function & Resolution Bandwidth	Quasi-Peak (QP) / Average (AV), 9kHz
Input Power	110Vac, 60Hz	Environmental Conditions	26 °C, 78% RH, 1001 mbar
Tested by	Ernie Liang		

Phase Of Power : Line (L)										
No	Frequency (MHz)	Correction Factor (dB)	Reading Value (dBuV)		Emission Level (dBuV)		Limit (dBuV)		Margin (dB)	
			Q.P.	AV.	Q.P.	AV.	Q.P.	AV.	Q.P.	AV.
1	0.49999	10.09	48.36	47.79	58.45	57.88	79.00	66.00	-20.55	-8.12
2	0.99973	10.15	47.36	45.62	57.51	55.77	73.00	60.00	-15.49	-4.23
3	1.49997	10.18	36.56	30.51	46.74	40.69	73.00	60.00	-26.26	-19.31
4	1.99600	10.21	33.17	31.18	43.38	41.39	73.00	60.00	-29.62	-18.61
5	2.99600	10.27	30.25	28.83	40.52	39.10	73.00	60.00	-32.48	-20.90
6	6.38400	10.44	25.63	19.13	36.07	29.57	73.00	60.00	-36.93	-30.43

Remarks:

1. Q.P. and AV. are abbreviations of quasi-peak and average individually.
2. The emission levels of other frequencies were very low against the limit.
3. Margin value = Emission level – Limit value
4. Correction factor = Insertion loss + Cable loss
5. Emission Level = Correction Factor + Reading Value

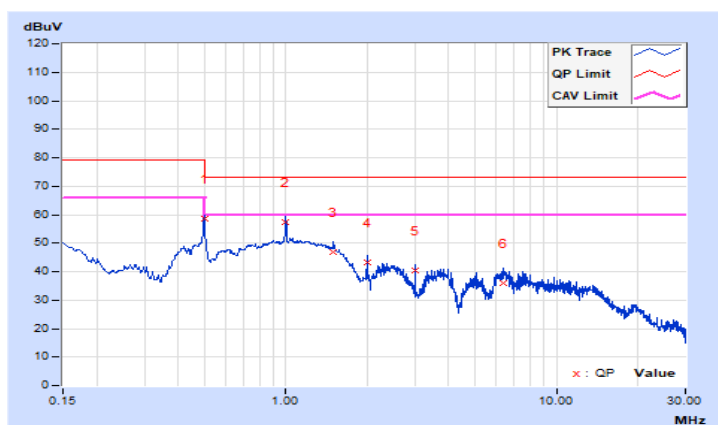

Frequency Range	150kHz ~ 30MHz	Detector Function & Resolution Bandwidth	Quasi-Peak (QP) / Average (AV), 9kHz
Input Power	110Vac, 60Hz	Environmental Conditions	26 °C, 78% RH, 1001 mbar
Tested by	Ernie Liang		

Phase Of Power : Neutral (N)										
No	Frequency (MHz)	Correction Factor (dB)	Reading Value (dBuV)		Emission Level (dBuV)		Limit (dBuV)		Margin (dB)	
			Q.P.	AV.	Q.P.	AV.	Q.P.	AV.	Q.P.	AV.
1	0.49999	10.11	48.92	48.34	59.03	58.45	79.00	66.00	-19.97	-7.55
2	1.00000	10.15	47.40	45.75	57.55	55.90	73.00	60.00	-15.45	-4.10
3	1.49997	10.18	36.58	31.21	46.76	41.39	73.00	60.00	-26.24	-18.61
4	1.99600	10.21	33.10	31.27	43.31	41.48	73.00	60.00	-29.69	-18.52
5	2.99784	10.27	30.19	28.78	40.46	39.05	73.00	60.00	-32.54	-20.95
6	6.01200	10.42	24.33	17.69	34.75	28.11	73.00	60.00	-38.25	-31.89

Remarks:

1. Q.P. and AV. are abbreviations of quasi-peak and average individually.
2. The emission levels of other frequencies were very low against the limit.
3. Margin value = Emission level – Limit value
4. Correction factor = Insertion loss + Cable loss
5. Emission Level = Correction Factor + Reading Value

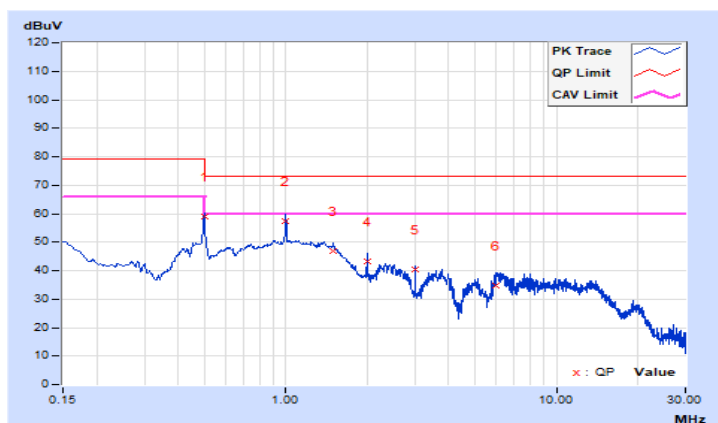

Frequency Range	150kHz ~ 30MHz	Detector Function & Resolution Bandwidth	Quasi-Peak (QP) / Average (AV), 9kHz
Input Power	230Vac, 50Hz	Environmental Conditions	26 °C, 78% RH, 1001 mbar
Tested by	Ernie Liang		

Phase Of Power : Line (L)										
No	Frequency (MHz)	Correction Factor (dB)	Reading Value (dBuV)		Emission Level (dBuV)		Limit (dBuV)		Margin (dB)	
			Q.P.	AV.	Q.P.	AV.	Q.P.	AV.	Q.P.	AV.
1	0.15000	10.06	37.56	21.78	47.62	31.84	79.00	66.00	-31.38	-34.16
2	0.49999	10.09	47.84	46.56	57.93	56.65	79.00	66.00	-21.07	-9.35
3	1.00000	10.15	46.55	44.40	56.70	54.55	73.00	60.00	-16.30	-5.45
4	1.99893	10.21	33.92	32.61	44.13	42.82	73.00	60.00	-28.87	-17.18
5	2.35200	10.23	28.95	23.24	39.18	33.47	73.00	60.00	-33.82	-26.53
6	6.13600	10.43	26.86	20.30	37.29	30.73	73.00	60.00	-35.71	-29.27

Remarks:

1. Q.P. and AV. are abbreviations of quasi-peak and average individually.
2. The emission levels of other frequencies were very low against the limit.
3. Margin value = Emission level – Limit value
4. Correction factor = Insertion loss + Cable loss
5. Emission Level = Correction Factor + Reading Value

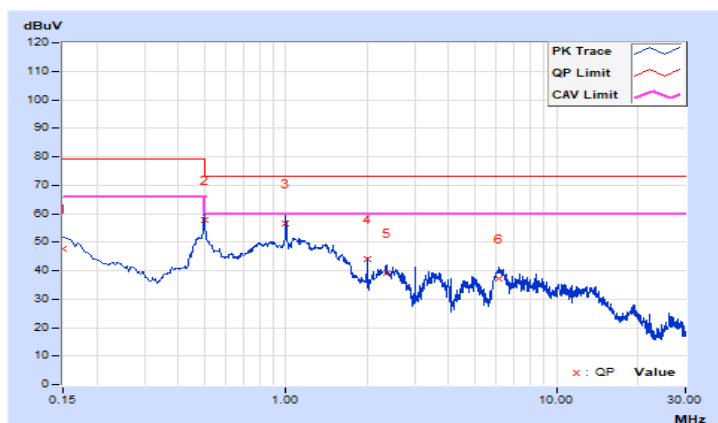

Frequency Range	150kHz ~ 30MHz	Detector Function & Resolution Bandwidth	Quasi-Peak (QP) / Average (AV), 9kHz
Input Power	230Vac, 50Hz	Environmental Conditions	26 °C, 78% RH, 1001 mbar
Tested by	Ernie Liang		

Phase Of Power : Neutral (N)										
No	Frequency (MHz)	Correction Factor (dB)	Reading Value (dBuV)		Emission Level (dBuV)		Limit (dBuV)		Margin (dB)	
			Q.P.	AV.	Q.P.	AV.	Q.P.	AV.	Q.P.	AV.
1	0.15770	10.08	35.79	18.22	45.87	28.30	79.00	66.00	-33.13	-37.70
2	0.49999	10.11	47.86	46.56	57.97	56.67	79.00	66.00	-21.03	-9.33
3	1.00000	10.15	47.10	45.33	57.25	55.48	73.00	60.00	-15.75	-4.52
4	1.38800	10.17	35.40	28.65	45.57	38.82	73.00	60.00	-27.43	-21.18
5	2.00000	10.21	33.53	32.19	43.74	42.40	73.00	60.00	-29.26	-17.60
6	6.09200	10.43	26.95	20.84	37.38	31.27	73.00	60.00	-35.62	-28.73

Remarks:

1. Q.P. and AV. are abbreviations of quasi-peak and average individually.
2. The emission levels of other frequencies were very low against the limit.
3. Margin value = Emission level – Limit value
4. Correction factor = Insertion loss + Cable loss
5. Emission Level = Correction Factor + Reading Value

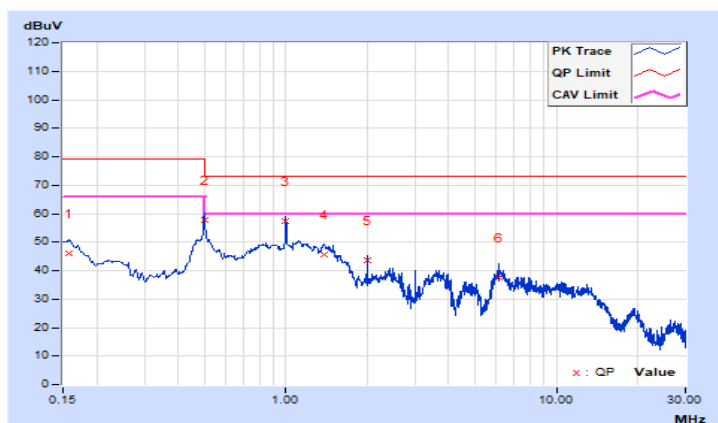

7.2 Conducted Emissions from Wired Network Ports

Mode 2 - RJ45 TELECOM PORT (1Gbps, TFGEN)

Frequency Range	150kHz ~ 30MHz	Detector Function & Resolution Bandwidth	Quasi-Peak (QP) / Average (AV), 9kHz
Input Power	230Vac, 50Hz	Environmental Conditions	26 °C, 78% RH, 1001 mbar
Tested by	Ernie Liang		

No	Frequency (MHz)	Correction Factor (dB)	Reading Value (dBuV)		Emission Level (dBuV)		Limit (dBuV)		Margin (dB)	
			Q.P.	AV.	Q.P.	AV.	Q.P.	AV.	Q.P.	AV.
1	0.49999	9.61	62.77	61.97	72.38	71.58	87.00	74.00	-14.62	-2.42
2	1.00000	9.59	55.04	53.31	64.63	62.90	87.00	74.00	-22.37	-11.10
3	1.49997	9.61	42.30	37.55	51.91	47.16	87.00	74.00	-35.09	-26.84
4	1.99893	9.64	38.36	37.75	48.00	47.39	87.00	74.00	-39.00	-26.61
5	5.80800	9.81	34.34	27.61	44.15	37.42	87.00	74.00	-42.85	-36.58
6	22.09600	10.12	30.99	24.40	41.11	34.52	87.00	74.00	-45.89	-39.48

Remarks:

1. Q.P. and AV. are abbreviations of quasi-peak and average individually.
2. The emission levels of other frequencies were very low against the limit.
3. Margin value = Emission level – Limit value
4. Correction factor = Insertion loss + Cable loss
5. Emission Level = Correction Factor + Reading Value

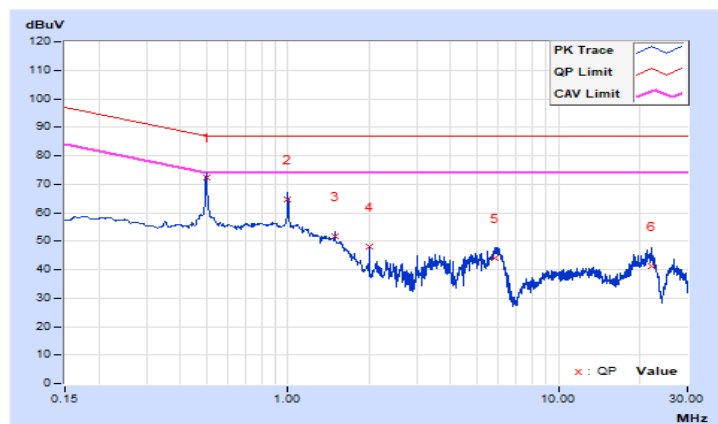

7.3 Radiated Emissions up to 1 GHz

Mode 2

Frequency Range	30MHz ~ 1GHz	Detector Function & Resolution Bandwidth	Quasi-Peak (QP), 120kHz
Tested By	ED. Lin	Environmental Conditions	36 °C, 73% RH, 1003 mbar

Antenna Polarity & Test Distance : Horizontal at 10 m								
No	Frequency (MHz)	Emission Level (dBuV/m)	Limit (dBuV/m)	Margin (dB)	Antenna Height (m)	Table Angle (Degree)	Raw Value (dBuV)	Correction Factor (dB/m)
1	62.26	28.65 QP	40.00	-11.35	4.00 H	311	39.57	-10.92
2	162.28	37.86 QP	40.00	-2.14	4.00 H	24	47.05	-9.19
3	170.53	34.16 QP	40.00	-5.84	3.81 H	166	43.68	-9.52
4	202.74	32.82 QP	40.00	-7.18	3.86 H	96	45.12	-12.30
5	296.73	38.39 QP	47.00	-8.61	3.14 H	157	46.29	-7.90
6	466.72	42.86 QP	47.00	-4.14	2.04 H	305	46.97	-4.11
7	741.85	37.96 QP	47.00	-9.04	1.36 H	161	36.11	1.85
8	890.62	39.10 QP	47.00	-7.90	1.00 H	158	34.41	4.69

Remarks:

1. Emission Level(dBuV/m) = Raw Value(dBuV) + Correction Factor(dB/m)
2. Correction Factor(dB/m) = Antenna Factor (dB/m) + Cable Factor (dB)
– Pre-Amplifier Factor (dB)
3. The other emission levels were very low against the limit.
4. Margin value = Emission level – Limit value

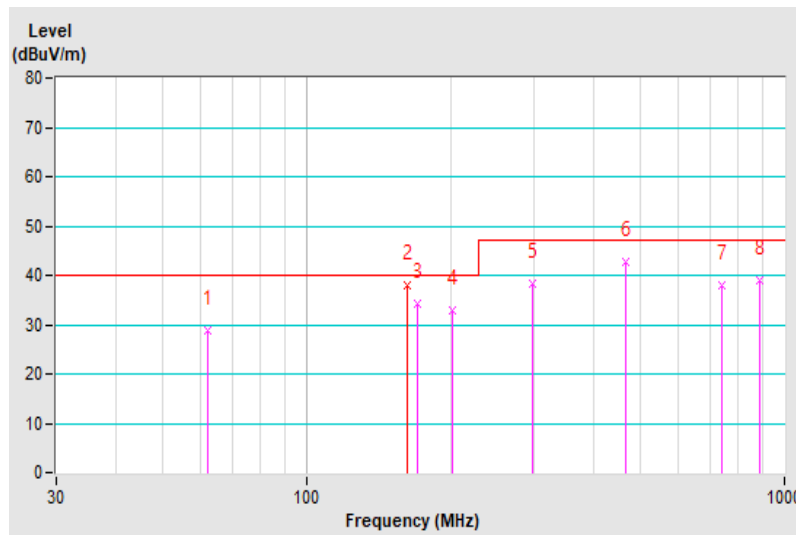

Frequency Range	30MHz ~ 1GHz	Detector Function & Resolution Bandwidth	Quasi-Peak (QP), 120kHz
Tested By	ED. Lin	Environmental Conditions	36 °C, 73% RH, 1003 mbar

Antenna Polarity & Test Distance : Vertical at 10 m								
No	Frequency (MHz)	Emission Level (dBuV/m)	Limit (dBuV/m)	Margin (dB)	Antenna Height (m)	Table Angle (Degree)	Raw Value (dBuV)	Correction Factor (dB/m)
1	78.24	32.12 QP	40.00	-7.88	1.00 V	126	46.61	-14.49
2	153.44	35.86 QP	40.00	-4.14	1.00 V	228	45.09	-9.23
3	162.47	39.00 QP	40.00	-1.00	1.00 V	2	48.21	-9.21
4	164.51	39.45 QP	40.00	-0.55	1.00 V	2	48.73	-9.28
5	296.73	41.36 QP	47.00	-5.64	1.00 V	22	49.26	-7.90
6	741.52	37.75 QP	47.00	-9.25	1.98 V	110	35.92	1.83
7	890.48	38.32 QP	47.00	-8.68	2.57 V	99	33.63	4.69

Remarks:

1. Emission Level(dBuV/m) = Raw Value(dBuV) + Correction Factor(dB/m)
2. Correction Factor(dB/m) = Antenna Factor (dB/m) + Cable Factor (dB)
– Pre-Amplifier Factor (dB)
3. The other emission levels were very low against the limit.
4. Margin value = Emission level – Limit value

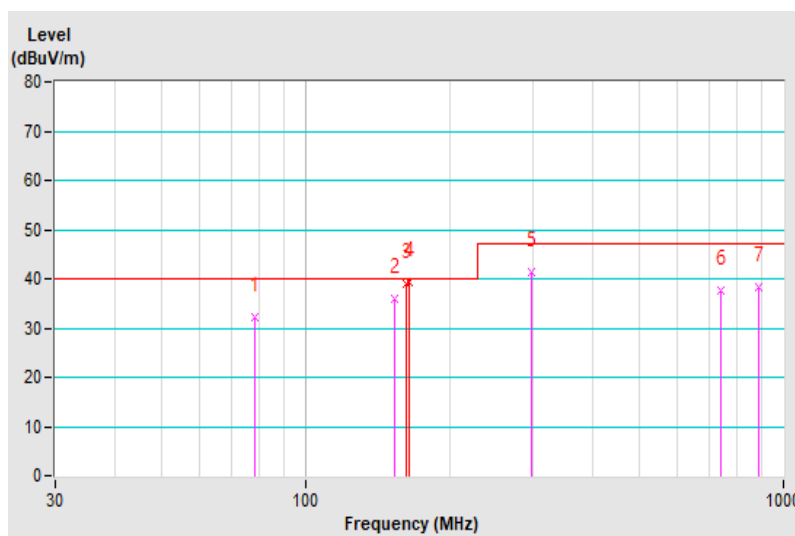

7.4 Radiated Emissions above 1 GHz

Mode 2

Frequency Range	1GHz ~ 6GHz	Detector Function & Resolution Bandwidth	Peak (PK) / Average (AV), 1MHz
Tested By	Vincent Lin	Environmental Conditions	26 °C, 60% RH, 1002 mbar

Antenna Polarity & Test Distance : Horizontal at 3 m								
No	Frequency (MHz)	Emission Level (dBuV/m)	Limit (dBuV/m)	Margin (dB)	Antenna Height (m)	Table Angle (Degree)	Raw Value (dBuV)	Correction Factor (dB/m)
1	1483.45	63.28 PK	76.00	-12.72	1.01 H	153	67.43	-4.15
2	1483.45	45.95 AV	56.00	-10.05	1.01 H	153	50.10	-4.15
3	1500.04	57.65 PK	76.00	-18.35	1.65 H	153	61.77	-4.12
4	1500.04	42.26 AV	56.00	-13.74	1.65 H	153	46.38	-4.12
5	2000.05	59.93 PK	76.00	-16.07	1.00 H	112	60.49	-0.56
6	2000.05	41.37 AV	56.00	-14.63	1.00 H	112	41.93	-0.56
7	2499.94	65.71 PK	76.00	-10.29	2.10 H	209	67.02	-1.31
8	2499.94	47.17 AV	56.00	-8.83	2.10 H	209	48.48	-1.31
9	3499.95	62.76 PK	80.00	-17.24	1.00 H	196	60.99	1.77
10	3499.95	44.91 AV	60.00	-15.09	1.00 H	196	43.14	1.77
11	4498.84	60.55 PK	80.00	-19.45	1.00 H	107	57.88	2.67
12	4498.84	42.88 AV	60.00	-17.12	1.00 H	107	40.21	2.67
13	5488.69	63.01 PK	80.00	-16.99	1.00 H	107	57.71	5.30
14	5488.69	44.88 AV	60.00	-15.12	1.00 H	107	39.58	5.30

Remarks:

1. Emission Level(dBuV/m) = Raw Value(dBuV) + Correction Factor(dB/m)
2. Correction Factor(dB/m) = Antenna Factor (dB/m) + Cable Factor (dB) – Pre-Amplifier Factor (dB)
3. The other emission levels were very low against the limit.
4. Margin value = Emission level – Limit value

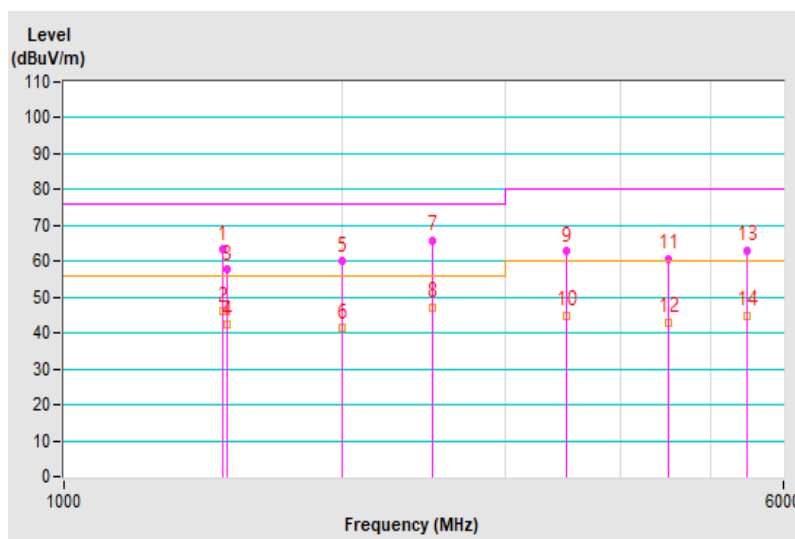

Frequency Range	1GHz ~ 6GHz	Detector Function & Resolution Bandwidth	Peak (PK) / Average (AV), 1MHz
Tested By	Vincent Lin	Environmental Conditions	26 °C, 60% RH, 1002 mbar

Antenna Polarity & Test Distance : Vertical at 3 m								
No	Frequency (MHz)	Emission Level (dBuV/m)	Limit (dBuV/m)	Margin (dB)	Antenna Height (m)	Table Angle (Degree)	Raw Value (dBuV)	Correction Factor (dB/m)
1	1186.83	53.25 PK	76.00	-22.75	1.00 V	206	57.85	-4.60
2	1186.83	43.96 AV	56.00	-12.04	1.00 V	206	48.56	-4.60
3	1384.55	56.29 PK	76.00	-19.71	2.11 V	295	60.65	-4.36
4	1384.55	39.98 AV	56.00	-16.02	2.11 V	295	44.34	-4.36
5	1499.75	60.36 PK	76.00	-15.64	1.01 V	125	64.48	-4.12
6	1499.75	47.20 AV	56.00	-8.80	1.01 V	125	51.32	-4.12
7	1780.21	55.05 PK	76.00	-20.95	2.00 V	324	57.80	-2.75
8	1780.21	40.99 AV	56.00	-15.01	2.00 V	324	43.74	-2.75
9	1990.77	62.62 PK	76.00	-13.38	1.73 V	117	63.22	-0.60
10	1990.77	32.89 AV	56.00	-23.11	1.73 V	117	33.49	-0.60
11	2928.65	59.48 PK	76.00	-16.52	2.54 V	175	59.31	0.17
12	2928.65	37.79 AV	56.00	-18.21	2.54 V	175	37.62	0.17
13	4498.74	57.43 PK	80.00	-22.57	1.00 V	129	54.76	2.67
14	4498.74	40.63 AV	60.00	-19.37	1.00 V	129	37.96	2.67
15	5488.55	60.26 PK	80.00	-19.74	1.05 V	7	54.96	5.30
16	5488.55	42.47 AV	60.00	-17.53	1.05 V	7	37.17	5.30

Remarks:

1. Emission Level(dBuV/m) = Raw Value(dBuV) + Correction Factor(dB/m)
2. Correction Factor(dB/m) = Antenna Factor (dB/m) + Cable Factor (dB) – Pre-Amplifier Factor (dB)
3. The other emission levels were very low against the limit.
4. Margin value = Emission level – Limit value

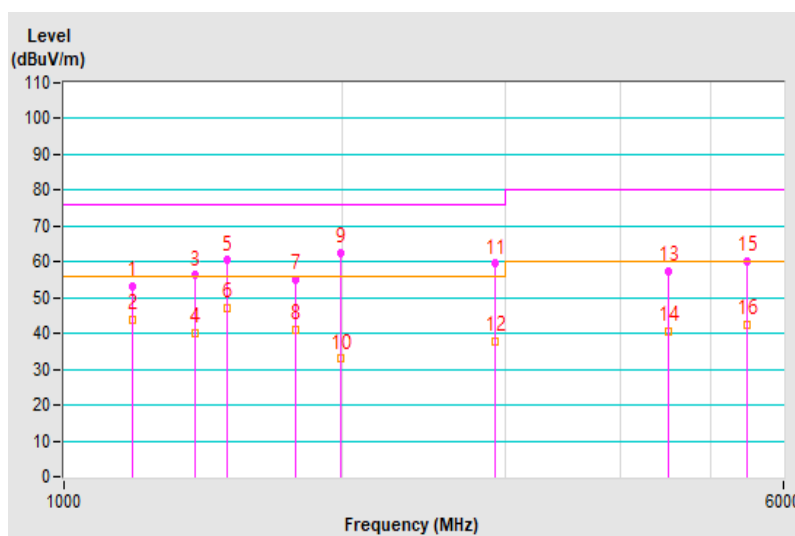

7.5 Harmonic Current Measurement

Mode 2

Test Duration	5 min	Fundamental Voltage / Ampere	230.57 Vrms / 0.295 Arms
Power Consumption	26.1 W	Power Frequency	50 Hz
Power Factor	0.401	Environmental Conditions	26 °C, 72% RH
Tested By	Aga Lin		

Notes:

1. Limits are not specified for equipment with a rated power of 75W or less (other than lighting equipment).
2. According to EN 61000-3-2 the manufacturer shall specify the power of the apparatus. This value shall be used for establishing limits. The specified power shall be within +/-10% of the measured power.

7.6 Voltage Fluctuations and Flicker Measurement

Mode 2

Observation (Tp)	10 min		
Input Power	230Vac,50Hz	Environmental Conditions	26 °C, 72% RH
Tested By	Aga Lin		

Test Parameter	Measurement Value	Limit	Remarks
P_{st}	0.064	1.00	Pass
P_{lt}	0.028	0.65	Pass
T_{max} (ms)	0	500	Pass
d_{max} (%)	0	4.00	Pass
d_c (%)	0	3.30	Pass

Notes:

1. P_{st} means short-term flicker indicator.
2. P_{lt} means long-term flicker indicator.
3. T_{max} means accumulated time value of $d(t)$ with a deviation exceeding 3.3 %.
4. d_{max} means maximum relative voltage change.
5. d_c means maximum relative steady-state voltage change.

7.7 Electrostatic Discharge (ESD)

Mode 2

Input Power	230Vac, 50 Hz	Tested by	Sean Chou
Environmental Conditions	24°C, 42% RH, 1001 mbar		

Test Results of Direct Application					
Discharge Level (kV)	Polarity (+/-)	Test Point	Contact Discharge	Air Discharge	Performance Criteria
2, 4	+/-	1-3	Note 1	NA	A
2, 4, 8	+/-	4-6, 10-13	NA	Note 1	A
2, 4	+/-	7-9	NA	Note 1	A
8	+/-	7-9	NA	Note 2	B

Description of test points of direct application: Please refer to following page for representative mark only.

Test Results of Indirect Application					
Discharge Level (kV)	Polarity (+/-)	Test Point	Horizontal Coupling Plane	Vertical Coupling Plane	Performance Criteria
2, 4	+/-	Four Sides	Note 1	Note 1	A

Description of test points of indirect application:

1. Front side
2. Rear side
3. Right side
4. Left side

Note: 1. The EUT is operated normal during the test.
 2. The burnIn was delayed 2 seconds during the test, but could self-recover after the test.

DESCRIPTION OF TEST POINT

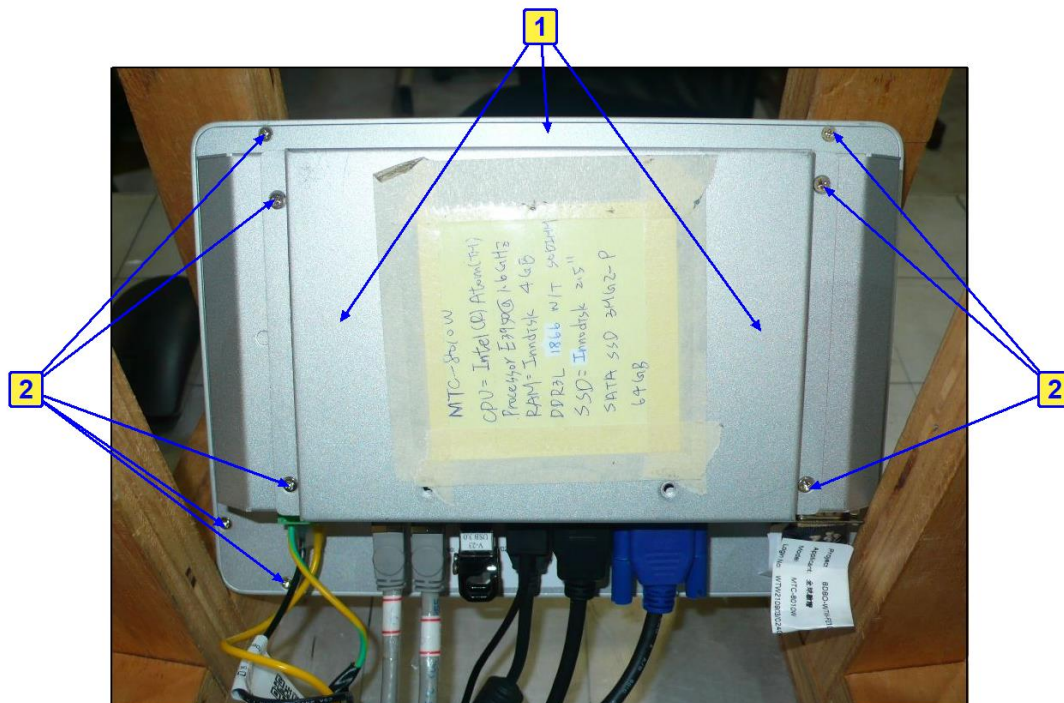
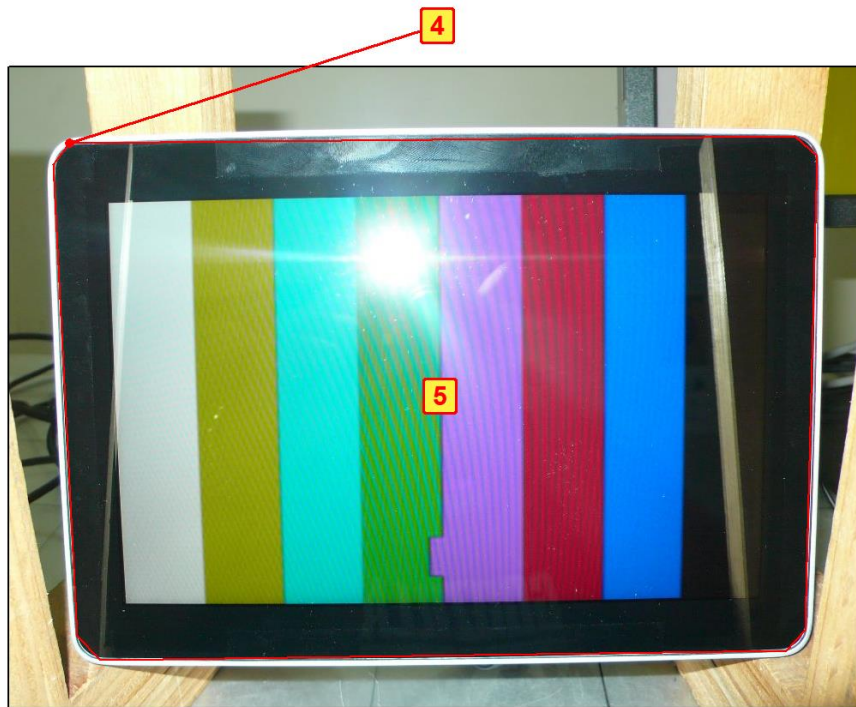

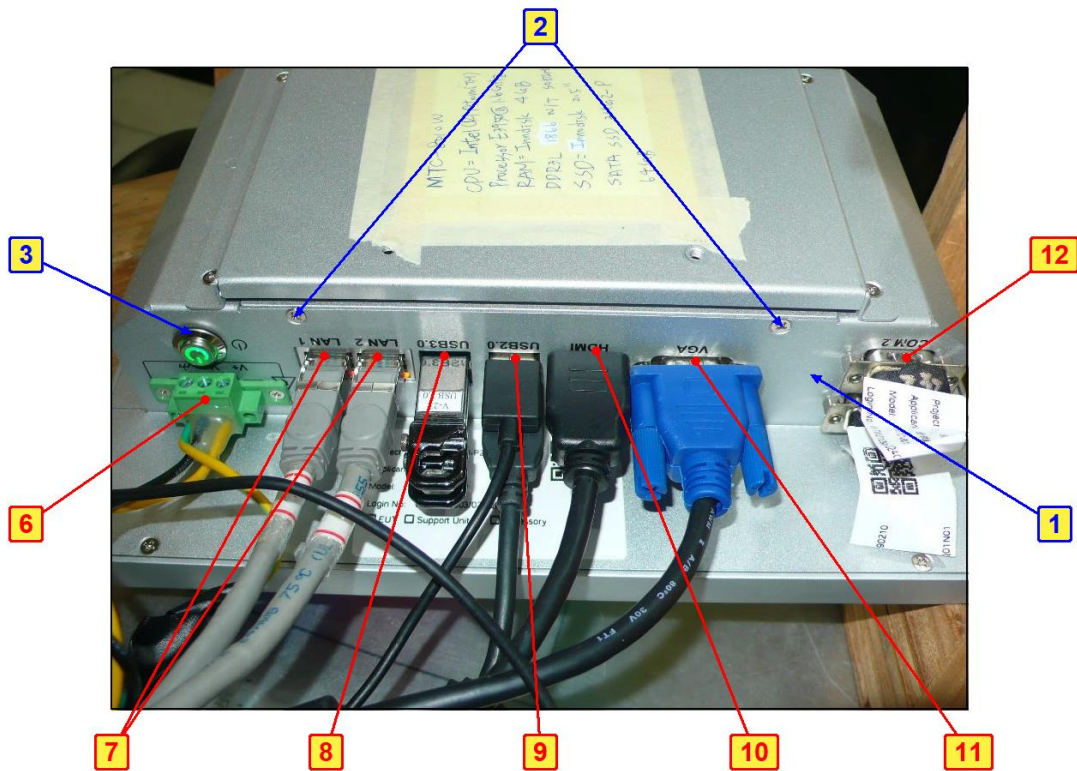

7.8 Radio Frequency Electromagnetic Field (RS)

Mode 2

Input Power	230Vac, 50 Hz	Tested by	Aga Lin
Environmental Conditions	26°C, 70% RH		

Frequency (MHz)	Polarity	Azimuth(°)	Applied Field Strength		Observation	Performance Criteria
			(V/m)	Modulation		
80 -1000	V&H	0	3	80% AM (1kHz)	Note	A
		90	3	80% AM (1kHz)	Note	A
		180	3	80% AM (1kHz)	Note	A
		270	3	80% AM (1kHz)	Note	A
1800, 2600, 3500, 5000	V&H	0	3	80% AM (1kHz)	Note	A
		90	3	80% AM (1kHz)	Note	A
		180	3	80% AM (1kHz)	Note	A
		270	3	80% AM (1kHz)	Note	A

Note: The EUT is operated normal during the test.

7.9 Fast Transients Common Mode (EFT)

Mode 2

Input Power	230Vac, 50 Hz	Tested by	Xun Lee
Environmental Conditions	25°C, 70% RH		

Input AC power port

Voltage (kV)	Test Point	Polarity (+/-)	Observation	Performance Criteria
1	L	+/-	Note	A
1	N	+/-	Note	A
1	PE	+/-	Note	A
1	L-N-PE	+/-	Note	A

Wired network and signal/ control port

Voltage (kV)	Test Point	Polarity (+/-)	Observation	Performance Criteria
0.5	LAN	+/-	Note	A

Note: The EUT is operated normal during the test.

7.10 Surge

Mode 2

Input Power	230Vac, 50 Hz	Tested by	Xun Lee
Environmental Conditions	25°C, 51% RH		

Input AC power port

Voltage (kV)	Test Point	Azimuth(°)	Polarity (+/-)	Observation	Performance Criteria
0.5, 1	L-N	90, 270	+/-	Note	A
0.5, 1, 2	L-PE	90, 270	+/-	Note	A
0.5, 1, 2	N-PE	90, 270	+/-	Note	A

Note: The EUT is operated normal during the test.

7.11 Radio Frequency Common Mode (CS)

Mode 2

Input Power	230Vac, 50 Hz	Tested by	Xun Lee
Environmental Conditions	25°C, 71% RH		

Input AC power port

Frequency (MHz)	Level (Vrms)	Tested Line	Injection Method	Return Path	Observation	Performance Criteria
0.15 – 10	3	AC Power	CDN-M3	CDN-M1	Note	A
10 – 30	3 – 1	AC Power	CDN-M3	CDN-M1	Note	A
30 – 80	1	AC Power	CDN-M3	CDN-M1	Note	A
0.15 – 10	3	LAN	CDN-ST08A	CDN-M1	Note	A
10 – 30	3 – 1	LAN	CDN-ST08A	CDN-M1	Note	A
30 – 80	1	LAN	CDN-ST08A	CDN-M1	Note	A

Note: The EUT is operated normal during the test.

7.12 Power Frequency Magnetic Field (PFMF)

Mode 2

Input Power	230Vac, 50 Hz	Tested by	Aga Lin
Environmental Conditions	25°C, 69% RH		

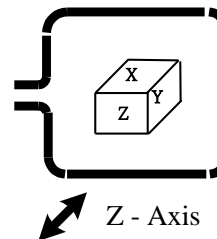
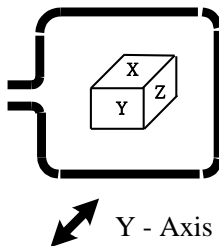
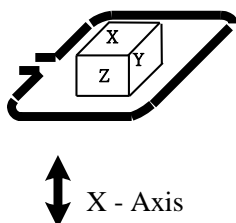

Application	Frequency (Hz)	Field Strength (A/m)	Observation	Performance Criteria
X - Axis	50	1	Note	A
Y - Axis	50	1	Note	A
Z - Axis	50	1	Note	A

Note: The EUT is operated normal during the test.

7.13 Voltage Dips and Interruptions (DIP)

Mode 2

Input Power	230Vac, 50 Hz; 240Vac, 50 Hz; 100Vac, 50 Hz	Tested by	Aga Lin
Environmental Conditions	25°C, 69% RH		

Input Power for testing: 230Vac, 50 Hz (Nominal input Voltage)					
Voltage Residual (%)	Duration (cycle)	Interval (sec)	Times	Observation	Performance Criteria
< 5	0.5	10	3	Note 1	A
70	25	10	3	Note 1	A
< 5	250	10	3	Note 2	C

Input Power for testing: 240Vac, 50 Hz (Maximum rated input voltage)					
Voltage Residual (%)	Duration (cycle)	Interval (sec)	Times	Observation	Performance Criteria
< 5	0.5	10	3	Note 1	A
70	25	10	3	Note 1	A
< 5	250	10	3	Note 2	C

Input Power for testing: 100Vac, 50 Hz (Minimum rated input voltage)					
Voltage Residual (%)	Duration (cycle)	Interval (sec)	Times	Observation	Performance Criteria
< 5	0.5	10	3	Note 1	A
70	25	10	3	Note 1	A
< 5	250	10	3	Note 2	C

- Note: 1. The EUT is operated normal during the test.
2. The EUT appears a "reboot" phenomena during the test, need manual recoverable after the test.

8 Pictures of Test Arrangements

8.1 Conducted Emissions from Power Ports

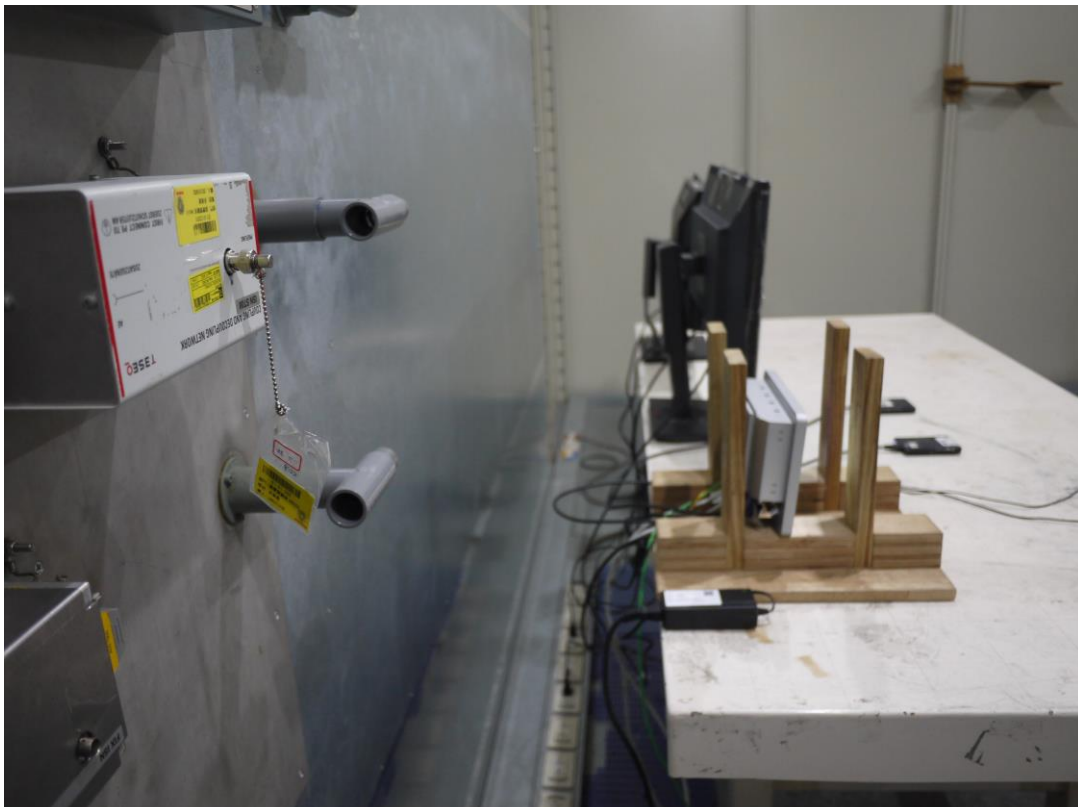

8.2 Conducted Emissions from Wired Network Ports



8.3 Radiated Emissions up to 1 GHz

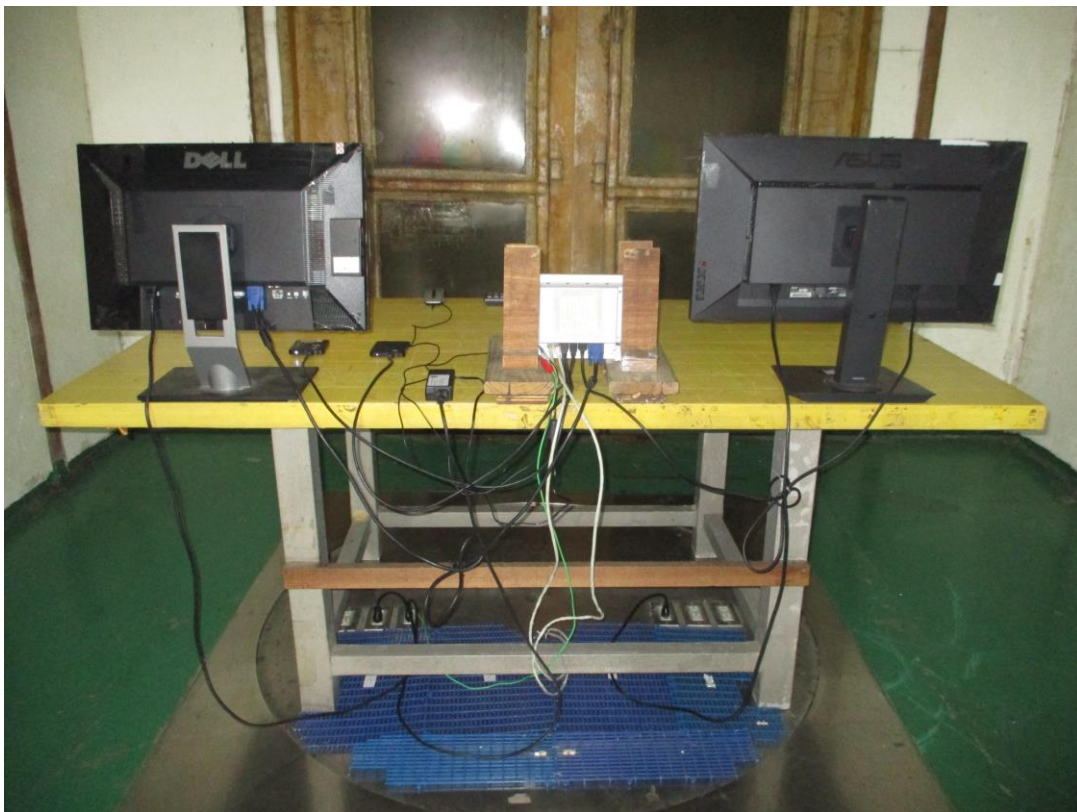

8.4 Radiated Emissions above 1 GHz

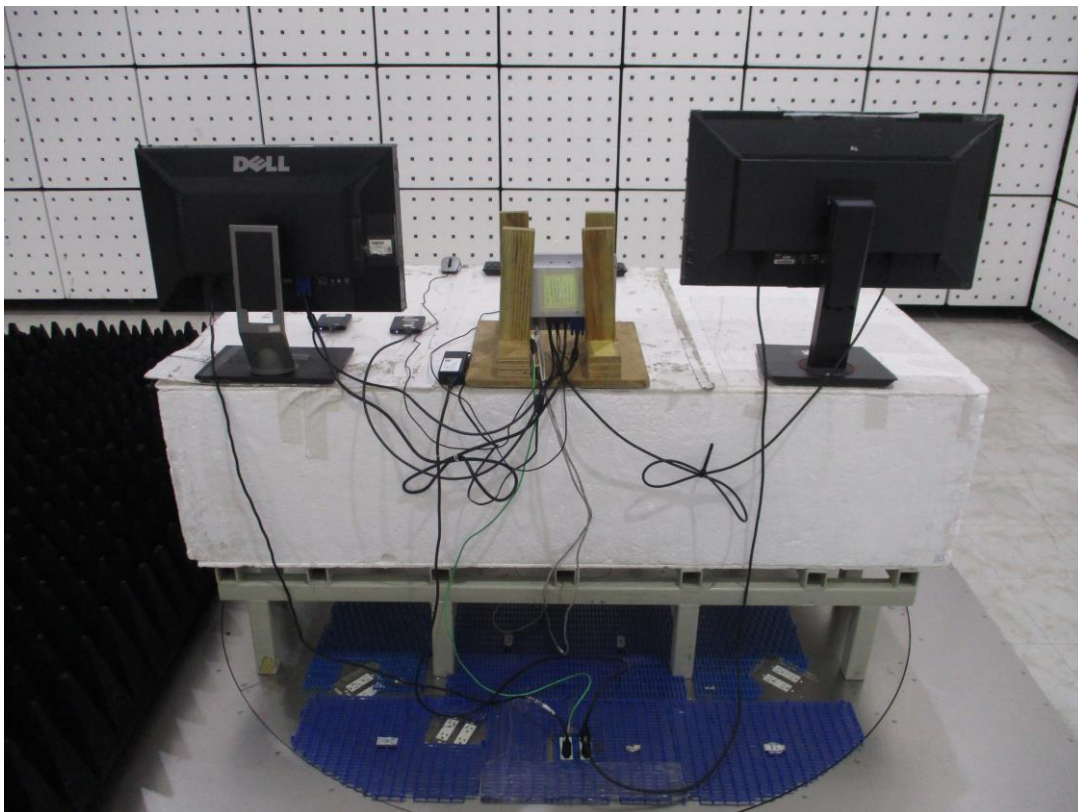

8.5 Harmonic Current Measurement



8.6 Voltage Fluctuations and Flicker Measurement



8.7 Electrostatic Discharge (ESD)



8.8 Radio Frequency Electromagnetic Field (RS)



8.9 Fast Transients Common Mode (EFT)

Mains port



LAN port



8.10 Surge

Mains port



8.11 Radio Frequency Common Mode (CS)

Mains port

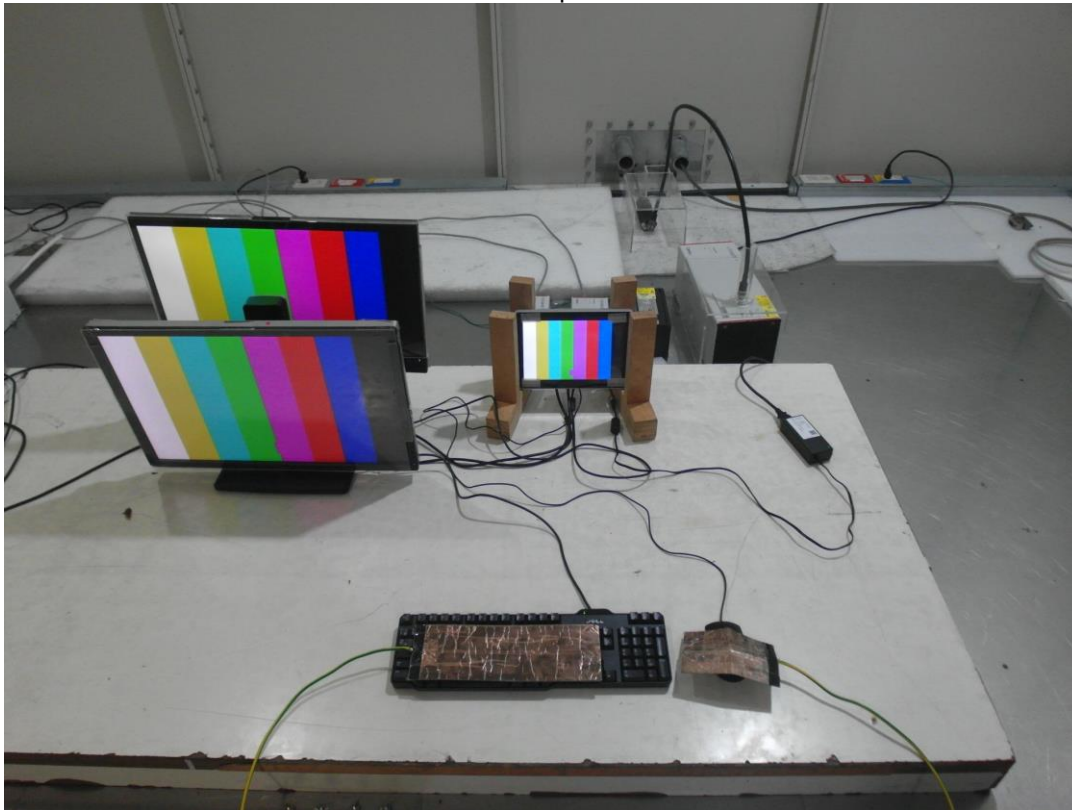

LAN port

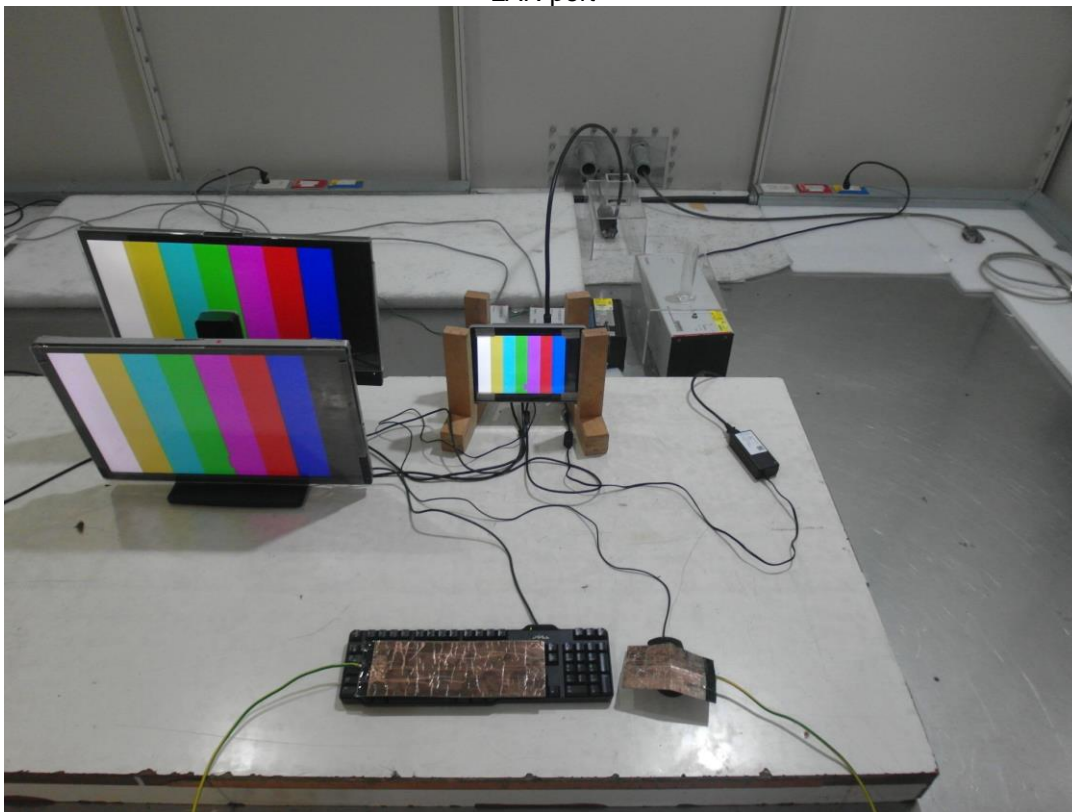

8.12 Power-frequency magnetic fields (PFMF)

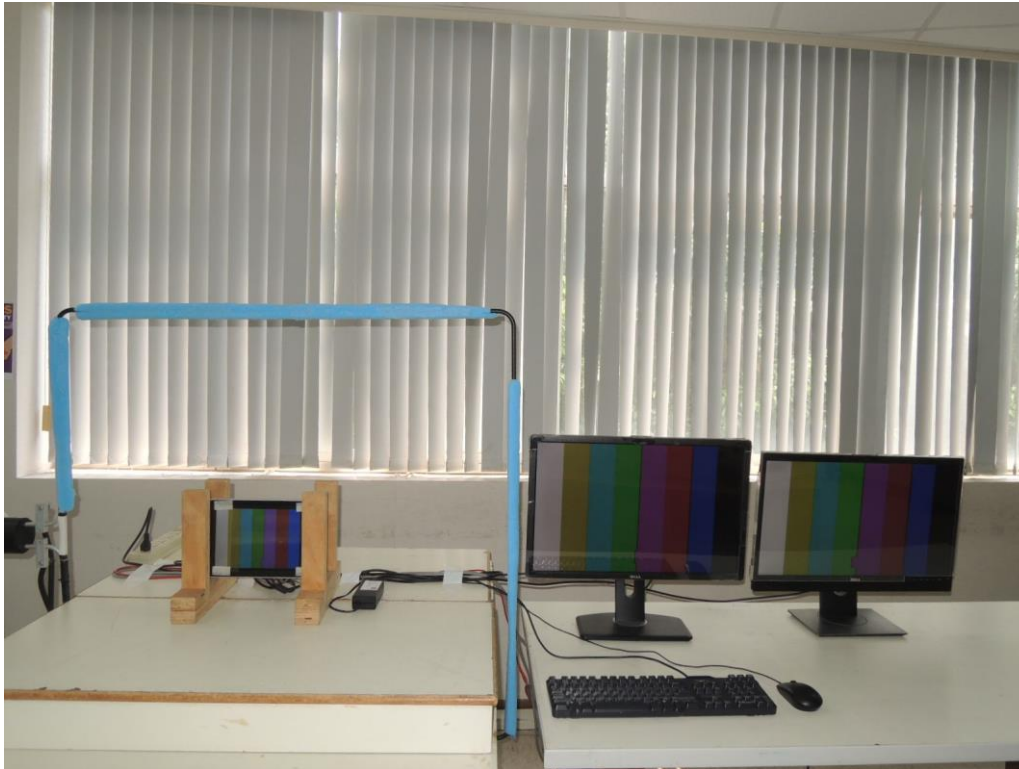

8.13 Voltage Dips and Interruptions (DIP)



9 Information of the Testing Laboratories

We, Bureau Veritas Consumer Products Services (H.K.) Ltd., Taoyuan Branch, were founded in 1988 to provide our best service in EMC, Radio, Telecom and Safety consultation. Our laboratories are accredited and approved according to ISO/IEC 17025.

If you have any comments, please feel free to contact us at the following:

Lin Kou EMC/RF Lab

Tel: 886-2-26052180

Fax: 886-2-26051924

Hsin Chu EMC/RF/Telecom Lab

Tel: 886-3-6668565

Fax: 886-3-6668323

Hwa Ya EMC/RF/Safety Lab

Tel: 886-3-3183232

Fax: 886-3-3270892

Email: service.adt@tw.bureauveritas.com

Web Site: www.bureauveritas-adt.com

The address and road map of all our labs can be found in our web site also.

--- END ---